

Catalogue

Panelboards and Telecommunication Panels



Panelboards and Telecommunication Panels

omega

Low Profile (Depth 113 mm)

- Distribution Panelboard	5
- Telecommunication Panelboard	10
- Accessories	12

beta

Low Depth (Depth 75 mm)

- Distribution Panelboard	14
- Telecommunications Complete Box	18
- Accessories	19

gamma

Standard (Depth 113 mm)

- Distribution Panelboard	21
- Accessories	25
- Telecommunication Panelboard	27
- Accessories	29

Technical Information	30
------------------------------	----

omega

**Low
Profile Door**



**Where discretion is a
priority**

113 mm back box and **11 mm door**, provides an easy and effective wiring organization.

Several installation possibilities of Brass Terminals.

Removable chassis to allow electrification on workbench.

Reversible door.

Easy to maintain, quick removal of masks.

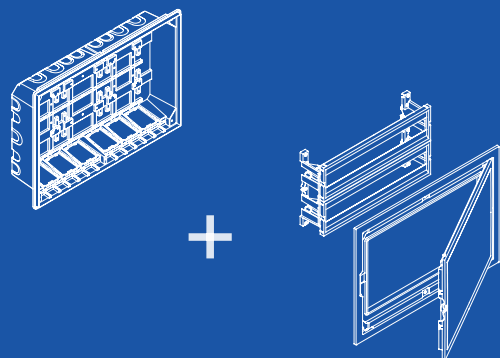

Distribution Panelboard - Semi-assembled

ref.

ref.

4 Modules (1x4)



Interior Fitting and Door for Low Profile Distribution Panelboard

External dimensions (mm): 217 x 275 x 11.

Accessories:

- Brass Terminal with 9 Neutral Connections (Ref. 60902) - 1 unit;
- Brass Terminal with 9 Earth Connections (Ref. 60903) - 1 unit;
- Supplied with DIN rail, self-adhesive circuit identification sheet and labels.

62004 1JB



Flush Mounting Box for Panelboard

External dimensions (mm): 192 x 255 x 113.

850 °C resistant back box suitable for installation in masonry or hollow walls.

60004 1GB

8 Modules (1x8)



Interior Fitting and Door for Low Profile Distribution Panelboard

External dimensions (mm): 289 x 275 x 11.

Accessories:

- Brass Terminal with 9 Neutral Connections (Ref. 60902) - 1 unit;
- Brass Terminal with 9 Earth Connections (Ref. 60903) - 1 unit;
- Supplied with DIN rail, self-adhesive circuit identification sheet and labels.

62008 1JB



Flush Mounting Box for Panelboard

External dimensions (mm): 264 x 255 x 113.

850 °C resistant back box suitable for installation in masonry or hollow walls.

60008 1GB

12 Modules (1x12)



Interior Fitting and Door for Low Profile Distribution Panelboard

External dimensions (mm): 361 x 275 x 11.

Accessories:

- Brass Terminal with 9 Neutral Connections (Ref. 60902) - 1 unit;
- Brass Terminal with 9 Earth Connections (Ref. 60903) - 1 unit;
- Supplied with DIN rail, self-adhesive circuit identification sheet and labels.

62012 1JB



Flush Mounting Box for Panelboard

External dimensions (mm): 336 x 255 x 113.

850 °C resistant back box suitable for installation in masonry or hollow walls.

60012 1GB

16 Modules (2x8)



Interior Fitting and Door for Low Profile Distribution Panelboard

External dimensions (mm): 289 x 400 x 11.

Accessories:

- Brass Terminal with 9 Neutral Connections (Ref. 60902) - 1 unit;
- Brass Terminal with 9 Earth Connections (Ref. 60903) - 1 unit;
- Supplied with DIN rail, self-adhesive circuit identification sheet and labels.

62016 2JB



Flush Mounting Box for Panelboard

External dimensions (mm): 264 x 380 x 113.

850 °C resistant back box suitable for installation in masonry or hollow walls.

60016 2GB

24 Modules (2x12)



Interior Fitting and Door for Low Profile Distribution Panelboard

External dimensions (mm): 361 x 400 x 11.

Accessories:

- Brass Terminal with 9 Neutral Connections (Ref. 60902) - 2 units;
- Brass Terminal with 20 Earth Connections (Ref. 60905) - 1 unit;
- Supplied with DIN rail, self-adhesive circuit identification sheet and labels and filler plate.

62024 2JB



Flush Mounting Box for Panelboard

External dimensions (mm): 336 x 380 x 113.

850 °C resistant back box suitable for installation in masonry or hollow walls.

60024 2GB

External dimensions (mm): **W** - Width x **H** - Height x **D** - Depth.

Distribution Panelboard - Semi-assembled

ref.

ref.

32 Modules (2x16)



Interior Fitting and Door for Low Profile Distribution Panelboard

External dimensions (mm): 433 x 400 x 11.

Accessories:

- Brass Terminal with 9 Neutral Connections (Ref. 60902) - 2 units;
- Brass Terminal with 9 Earth Connections (Ref. 60903) - 1 unit;
- Brass Terminal with 20 Earth Connections (Ref. 60905) - 1 unit;
- Supplied with DIN rail, self-adhesive circuit identification sheet and labels and filler plate.

62032 2JB



Flush Mounting Box for Panelboard

External dimensions (mm): 408 x 380 x 113.
850 °C resistant back box suitable for installation in masonry or hollow walls.

60032 2GB

40 Modules (2x20)



Interior Fitting and Door for Low Profile Distribution Panelboard

External dimensions (mm): 505 x 400 x 11.

Accessories:

- Brass Terminal with 9 Neutral Connections (Ref. 60902) - 1 unit;
- Brass Terminal with 9 Earth Connections (Ref. 60903) - 1 unit;
- Brass Terminal with 20 Earth Connections (Ref. 60905) - 1 unit;
- Brass Terminal with 20 Neutral Connections (Ref. 60904) - 1 unit;
- Supplied with DIN rail, self-adhesive circuit identification sheet and labels and filler plate.

62040 2JB



Flush Mounting Box for Panelboard

External dimensions (mm): 480 x 380 x 113.
850 °C resistant back box suitable for installation in masonry or hollow walls.

60040 2GB

48 Modules (2x24)



Interior Fitting and Door for Low Profile Distribution Panelboard

External dimensions (mm): 577 x 400 x 11.

Accessories:

- Brass Terminal with 9 Neutral Connections (Ref. 60902) - 2 units;
- Brass Terminal with 20 Neutral Connections (Ref. 60904) - 1 unit;
- Brass Terminal with 20 Earth Connections (Ref. 60905) - 2 units;
- Supplied with DIN rail, self-adhesive circuit identification sheet and labels and filler plate.

62048 2JB



Flush Mounting Box for Panelboard

External dimensions (mm): 552 x 380 x 113.
850 °C resistant back box suitable for installation in masonry or hollow walls.

60048 2GB

60 Modules (3x20)



Interior Fitting and Door for Low Profile Distribution Panelboard

External dimensions (mm): 505 x 525 x 11.

Accessories:

- Brass Terminal with 9 Neutral Connections (Ref. 60902) - 2 units;
- Brass Terminal with 20 Neutral Connections (Ref. 60904) - 1 unit;
- Brass Terminal with 20 Earth Connections (Ref. 60905) - 2 units;
- Supplied with DIN rail, self-adhesive circuit identification sheet and labels and filler plate.

62060 3JB



Flush Mounting Box for Panelboard

External dimensions (mm): 480 x 505 x 113.
850 °C resistant back box suitable for installation in masonry or hollow walls.

60060 3GB

80 Modules (4x20)



Interior Fitting and Door for Low Profile Distribution Panelboard

External dimensions (mm): 505 x 650 x 11.

Accessories:

- Brass Terminal with 9 Neutral Connections (Ref. 60902) - 1 unit;
- Brass Terminal with 20 Neutral Connections (Ref. 60904) - 2 units;
- Brass Terminal with 20 Earth Connections (Ref. 60905) - 3 units;
- Supplied with DIN rail, self-adhesive circuit identification sheet and labels and filler plate (2 units).

62080 4JB







Flush Mounting Box for Panelboard

External dimensions (mm): 480 x 630 x 113.
850 °C resistant back box suitable for installation in masonry or hollow walls.

60080 4GB





External dimensions (mm): W - Width x H - Height x D - Depth.

Distribution Panelboard - Complete

		ref.	mod.	rows
4 Modules (1x4)	 <p>Complete Low Profile Flush Mounting Distribution Panelboard External dimensions (mm): 217 x 275 x 124. 850 °C resistant back box suitable for installation in masonry or hollow walls. Accessories: - Brass Terminal with 9 Neutral Connections (Ref. 60902) - 1 unit; - Brass Terminal with 9 Earth Connections (Ref. 60903) - 1 unit; - Supplied with DIN rail, self-adhesive circuit identification sheet and labels.</p>	62004 1AB	4	1
8 Modules (1x8)	 <p>Complete Low Profile Flush Mounting Distribution Panelboard External dimensions (mm): 289 x 275 x 124. 850 °C resistant back box suitable for installation in masonry or hollow walls. Accessories: - Brass Terminal with 9 Neutral Connections (Ref. 60902) - 1 unit; - Brass Terminal with 9 Earth Connections (Ref. 60903) - 1 unit; - Supplied with DIN rail, self-adhesive circuit identification sheet and labels.</p>	62008 1AB	8	1
12 Modules (1x12)	 <p>Complete Low Profile Flush Mounting Distribution Panelboard External dimensions (mm): 361 x 275 x 124. 850 °C resistant back box suitable for installation in masonry or hollow walls. Accessories: - Brass Terminal with 9 Neutral Connections (Ref. 60902) - 1 unit; - Brass Terminal with 9 Earth Connections (Ref. 60903) - 1 unit; - Supplied with DIN rail, self-adhesive circuit identification sheet and labels.</p>	62012 1AB	12	1
16 Modules (2x8)	 <p>Complete Low Profile Flush Mounting Distribution Panelboard External dimensions (mm): 289 x 400 x 124. 850 °C resistant back box suitable for installation in masonry or hollow walls. Accessories: - Brass Terminal with 9 Neutral Connections (Ref. 60902) - 1 unit; - Brass Terminal with 9 Earth Connections (Ref. 60903) - 1 unit; - Supplied with DIN rail, self-adhesive circuit identification sheet and labels.</p>	62016 2AB	16	2
24 Modules (2x12)	 <p>Complete Low Profile Flush Mounting Distribution Panelboard External dimensions (mm): 361 x 400 x 124. 850 °C resistant back box suitable for installation in masonry or hollow walls. Accessories: - Brass Terminal with 9 Neutral Connections (Ref. 60902) - 2 units; - Brass Terminal with 20 Earth Connections (Ref. 60905) - 1 unit; - Supplied with DIN rail, self-adhesive circuit identification sheet and labels and filler plate.</p>	62024 2AB	24	2

External dimensions (mm): **W** - Width x **H** - Height x **D** - Depth.

Distribution Panelboard - Complete

		ref.	mod.	rows
32 Modules (2x16)	 <p>Complete Low Profile Flush Mounting Distribution Panelboard External dimensions (mm): 433 x 400 x 124. 850 °C resistant back box suitable for installation in masonry or hollow walls. Accessories: - Brass Terminal with 9 Neutral Connections (Ref. 60902) - 2 units; - Brass Terminal with 9 Earth Connections (Ref. 60903) - 1 unit; - Brass Terminal with 20 Earth Connections (Ref. 60905) - 1 unit; - Supplied with DIN rail, self-adhesive circuit identification sheet and labels and filler plate.</p>	62032 2AB	32	2
40 Modules (2x20)	 <p>Complete Low Profile Flush Mounting Distribution Panelboard External dimensions (mm): 505 x 400 x 124. 850 °C resistant back box suitable for installation in masonry or hollow walls. Accessories: - Brass Terminal with 9 Neutral Connections (Ref. 60902) - 1 unit; - Brass Terminal with 9 Earth Connections (Ref. 60903) - 1 unit; - Brass Terminal with 20 Earth Connections (Ref. 60905) - 1 unit; - Brass Terminal with 20 Neutral Connections (Ref. 60904) - 1 unit; - Supplied with DIN rail, self-adhesive circuit identification sheet and labels and filler plate.</p>	62040 2AB	40	2
48 Modules (2x24)	 <p>Complete Low Profile Flush Mounting Distribution Panelboard External dimensions (mm): 577 x 400 x 124. 850 °C resistant back box suitable for installation in masonry or hollow walls. Accessories: - Brass Terminal with 9 Neutral Connections (Ref. 60902) - 2 units; - Brass Terminal with 20 Neutral Connections (Ref. 60904) - 1 unit; - Brass Terminal with 20 Earth Connections (Ref. 60905) - 2 units; - Supplied with DIN rail, self-adhesive circuit identification sheet and labels and filler plate.</p>	62048 2AB	48	2
60 Modules (3x20)	 <p>Complete Low Profile Flush Mounting Distribution Panelboard External dimensions (mm): 505 x 525 x 124. 850 °C resistant back box suitable for installation in masonry or hollow walls. Accessories: - Brass Terminal with 9 Neutral Connections (Ref. 60902) - 2 units; - Brass Terminal with 20 Neutral Connections (Ref. 60904) - 1 unit; - Brass Terminal with 20 Earth Connections (Ref. 60905) - 2 units; - Supplied with DIN rail, self-adhesive circuit identification sheet and labels and filler plate.</p>	62060 3AB	60	3
80 Modules (4x20)	 <p>Complete Low Profile Flush Mounting Distribution Panelboard External dimensions (mm): 505 x 650 x 124. 850 °C resistant back box suitable for installation in masonry or hollow walls. Accessories: - Brass Terminal with 9 Neutral Connections (Ref. 60902) - 1 unit; - Brass Terminal with 20 Neutral Connections (Ref. 60904) - 2 units; - Brass Terminal with 20 Earth Connections (Ref. 60905) - 3 units; - Supplied with DIN rail, self-adhesive circuit identification sheet and labels and filler plate (2 units).</p>	62080 4AB	80	4

External dimensions (mm): **W** - Width x **H** - Height x **D** - Depth.

Telecom panelboard

COMPLETE LOW PROFILE FLUSH MOUNTING TELECOM PANELBOARD



8 Coaxial Cable Outputs (CC) and up to 24 Copper Pair Outputs (CP)

Complete Low Profile Flush Mounting Telecom Panelboard

External dimensions (mm): 505 x 525 x 124.

850 °C resistant back box suitable for installation in masonry or hollow walls.

ref. **62060 3SB**

Telecommunication Panelboard - Semi-assembled

ref.

ref.

6 Coaxial Cable Outputs (CC) and up to 12 Copper Pair Outputs (CP)



Interior Fitting and Door for Low Profile Telecom Panelboard

External dimensions (mm): 577 x 400 x 11.

Accessories:

- CP Splitter with connectors Cat. 6 UTP (1 input, 6 outputs, expandable to 12 outputs);
- Double Coaxial Splitter (2 inputs and 2 x 6 outputs);
- OF Splitter with SC/APC Simplex Optical Fibre Coupler;
- Schuko Socket (Ref. 45132 SBR).

62048 2LB



Flush Mounting Box for Panelboard

External dimensions (mm): 552 x 380 x 113.
850 °C resistant back box suitable for installation in masonry or hollow walls.

60048 2GB

8 Coaxial Cable Outputs (CC) and up to 24 Copper Pair Outputs (CP)



Interior Fitting and Door for Low Profile Telecom Panelboard

External dimensions (mm): 505 x 525 x 11.

Accessories:

- CP Splitter with connectors Cat. 6 UTP (1 input, 8 outputs, expandable to 24 outputs);
- Double Coaxial Splitter (2 inputs and 2 x 8 outputs);
- OF Splitter with SC/APC Simplex Optical Fibre Coupler;
- Schuko Socket (Ref. 45132 SBR).

62060 3NB



Flush Mounting Box for Panelboard

External dimensions (mm): 480 x 505 x 113.
850 °C resistant back box suitable for installation in masonry or hollow walls.

60060 3GB

12 Coaxial Cable Outputs (CC) and up to 24 Copper Pair Outputs (CP)



Interior Fitting and Door for Low Profile Telecom Panelboard

External dimensions (mm): 505 x 525 x 11.

Accessories:

- CP Splitter with connectors Cat. 6 UTP (1 input, 12 outputs, expandable to 24 outputs);
- Double Coaxial Splitter (2 inputs and 2 x 12 outputs);
- OF Splitter with SC/APC Simplex Optical Fibre Coupler;
- Schuko Socket (Ref. 45132 SBR).

62060 3MB



Flush Mounting Box for Panelboard

External dimensions (mm): 480 x 505 x 113.
850 °C resistant back box suitable for installation in masonry or hollow walls.

60060 3GB

Auxiliary Telecommunication Panelboard - Semi-assembled

6 Coaxial Cable Outputs (CC) and up to 12 Copper Pair Outputs (CP)



Low Profile Door for Telecom Back Box - 48 Modules

External dimensions (mm): 577 x 400 x 11.

62048 2QB



Flush Mounting Box for Panelboard

External dimensions (mm): 552 x 380 x 113.
850 °C resistant back box suitable for installation in masonry or hollow walls.

60048 2GB

12 Coaxial Cable Outputs (CC) and up to 24 Copper Pair Outputs (CP)



Low Profile Door for Telecom Back Box - 60 Modules

External dimensions (mm): 505 x 525 x 11.

62060 3RB



Flush Mounting Box for Panelboard

External dimensions (mm): 480 x 505 x 113.
850 °C resistant back box suitable for installation in masonry or hollow walls.

60060 3GB

CC - Coaxial Cable Outputs; PC - Copper Pair Outputs.
External dimensions (mm): W - Width x H - Height x D - Depth.

Telecommunication Panelboard - Complete

ref.

6 Coaxial Cable Outputs (CC) and up to 12 Copper Pair Outputs (CP)



Complete Low Profile Flush Mounting Telecom Panelboard

External dimensions (mm): **577 x 400 x 124**;

850 °C resistant back box suitable for installation in masonry or hollow walls.

Accessories:

- CP Splitter with connectors Cat. 6 UTP (1 input, 6 outputs, expandable to 12 outputs);
- Double Coaxial Splitter (2 inputs and 2 x 6 outputs);
- OF Splitter with SC/APC Simplex Optical Fibre Coupler;
- Schuko Socket (Ref. 45132 SBR).

62048 2PB

8 Coaxial Cable Outputs (CC) and up to 24 Copper Pair Outputs (CP)



Complete Low Profile Flush Mounting Telecom Panelboard

External dimensions (mm): **505 x 525 x 124**;

850 °C resistant back box suitable for installation in masonry or hollow walls.

Accessories:

- CP Splitter with connectors Cat. 6 UTP (1 input, 8 outputs, expandable to 24 outputs);
- Double Coaxial Splitter (2 inputs and 2 x 8 outputs);
- OF Splitter with SC/APC Simplex Optical Fibre Coupler;
- Schuko Socket (Ref. 45132 SBR).

62060 3SB

12 Coaxial Cable Outputs (CC) and up to 24 Copper Pair Outputs (CP)



Complete Low Profile Flush Mounting Telecom Panelboard

External dimensions (mm): **505 x 525 x 124**;

850 °C resistant back box suitable for installation in masonry or hollow walls.

Accessories:

- CP Splitter with connectors Cat. 6 UTP (1 input, 12 outputs, expandable to 24 outputs);
- Double Coaxial Splitter (2 inputs and 2 x 12 outputs);
- OF Splitter with SC/APC Simplex Optical Fibre Coupler;
- Schuko Socket (Ref. 45132 SBR).

62060 3PB

Auxiliary Telecommunication Panelboard - Complete

6 Coaxial Cable Outputs (CC) and up to 12 Copper Pair Outputs (CP)



Auxiliary Box for Complete Low Profile Flush Mounting Telecom Panelboard

External dimensions (mm): **577 x 400 x 124**.

850 °C resistant back box suitable for installation in masonry or hollow walls.

62048 2UB

12 Coaxial Cable Outputs (CC) and up to 24 Copper Pair Outputs (CP)



Auxiliary Box for Complete Low Profile Flush Mounting Telecom Panelboard











































External dimensions (mm): **505 x 525 x 124**.

850 °C resistant back box suitable for installation in masonry or hollow walls.



62060 3UB

CC - Coaxial Cable Outputs; PC - Copper Pair Outputs.
External dimensions (mm): W - Width x H - Height x D - Depth.

Accessories

			ref.
	Low Profile Panelboard Keylock	 	62900
	Low Profile Panelboard Rotary Lever Lock	 	62910
	Installation Kit for Hollow-Wall Flush Mounting Boxes	 	60914
	Connection for Panelboard Boxes with Cable Pass	 	60915
 	Brass Terminal with 9 Phase Connections	 	60901
 	Brass Terminal with 9 Neutral Connections	 	60902
 	Brass Terminal with 9 Earth Connections	 	60903
 	Brass Terminal with 20 Neutral Connections	 	60904
 	Brass Terminal with 20 Earth Connections	 	60905
	Coaxial Splitter 2x6 Outputs 5 - 862 MHz: 11 dB 950 - 2400 MHz: 15 dB F-Type, 5-2400 MHz, Flow DC 30 V 700 mA		60911
	Coaxial Splitter 2x8 Outputs 5 - 862 MHz: 12,5 dB 950 - 2400 MHz: 16 dB F-Type, 5-2400 MHz, Flow DC 30 V 700 mA		60913
	Coaxial Splitter 2x12 Outputs 5 - 862 MHz: 15,5 dB 950 - 2400 MHz: 21 dB F-Type, 5-2400 MHz, Flow DC 30 V 700 mA		60912
	Filler Plate 10 Modules		60906
	Optical Fibre Terminal Box		60907

 **Distribution Panelboard**
 **Telecommunication Panelboard**

 /  /  - Screw Connection

beta

Low Depth Back Box



With limited depth

75 mm Back Box and **35 mm Door**, ideal for narrow walls with thickness greater than 75 mm.

Removable chassis to allow electrification on workbench.

Reversible door.

Opens up to 180°.

Easy to maintain, quick removal of masks.

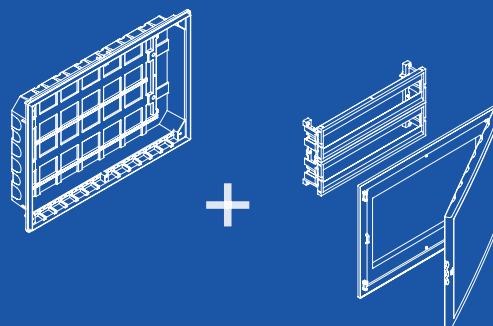

Distribution Panelboard - Semi-assembled

4 Modules (1x4)



Interior Fitting and Door for Flush Mounting Panelboard

External dimensions (mm): 217 x 275 x 35.

Accessories:

- Brass Terminal with 9 Neutral Connections (Ref. 60902) - 1 unit;
- Brass Terminal with 9 Earth Connections (Ref. 60903) - 1 unit;
- Supplied with DIN rail, self-adhesive circuit identification sheet and labels.

ref.

61004 1JB



Low Depth Flush Mounting Box for Panelboard

External dimensions (mm): 192 x 255 x 75.
850 °C resistant back box suitable for installation in masonry or hollow walls.

ref.

61004 1GB

8 Modules (1x8)



Interior Fitting and Door for Flush Mounting Panelboard

External dimensions (mm): 289 x 275 x 35.

Accessories:

- Brass Terminal with 9 Neutral Connections (Ref. 60902) - 1 unit;
- Brass Terminal with 9 Earth Connections (Ref. 60903) - 1 unit;
- Supplied with DIN rail, self-adhesive circuit identification sheet and labels.

61008 1JB



Low Depth Flush Mounting Box for Panelboard

External dimensions (mm): 264 x 255 x 75.
850 °C resistant back box suitable for installation in masonry or hollow walls.

61008 1GB

12 Modules (1x12)



Interior Fitting and Door for Flush Mounting Panelboard

External dimensions (mm): 361 x 275 x 35.

Accessories:

- Brass Terminal with 9 Neutral Connections (Ref. 60902) - 1 unit;
- Brass Terminal with 9 Earth Connections (Ref. 60903) - 1 unit;
- Supplied with DIN rail, self-adhesive circuit identification sheet and labels.

61012 1JB



Low Depth Flush Mounting Box for Panelboard

External dimensions (mm): 336 x 255 x 75.
850 °C resistant back box suitable for installation in masonry or hollow walls.

61012 1GB

16 Modules (2x8)



Interior Fitting and Door for Flush Mounting Panelboard

External dimensions (mm): 289 x 400 x 35.

Accessories:

- Brass Terminal with 9 Neutral Connections (Ref. 60902) - 1 unit;
- Brass Terminal with 9 Earth Connections (Ref. 60903) - 1 unit;
- Supplied with DIN rail, self-adhesive circuit identification sheet and labels.

61016 2JB



Low Depth Flush Mounting Box for Panelboard

External dimensions (mm): 264 x 380 x 75.
850 °C resistant back box suitable for installation in masonry or hollow walls.

61016 2GB

24 Modules (2x12)



Interior Fitting and Door for Flush Mounting Panelboard

External dimensions (mm): 361 x 400 x 35.

Accessories:

- Brass Terminal with 9 Neutral Connections (Ref. 60902) - 2 units;
- Brass Terminal with 20 Earth Connections (Ref. 60905) - 1 unit;
- Supplied with DIN rail, self-adhesive circuit identification sheet and labels and filler plate.

61024 2JB



Low Depth Flush Mounting Box for Panelboard

External dimensions (mm): 336 x 380 x 75.
850 °C resistant back box suitable for installation in masonry or hollow walls.

61024 2GB

External dimensions (mm): **W** - Width x **H** - Height x **D** - Depth.

Distribution Panelboard - Semi-assembled

ref.

ref.

32 Modules (2x16)



Interior Fitting and Door for Flush Mounting Panelboard

External dimensions (mm): 433 x 400 x 35.

Accessories:

- Brass Terminal with 9 Neutral Connections (Ref. 60902) - 2 units;
- Brass Terminal with 9 Earth Connections (Ref. 60903) - 1 unit;
- Brass Terminal with 20 Earth Connections (Ref. 60905) - 1 unit;
- Supplied with DIN rail, self-adhesive circuit identification sheet and labels and filler plate.

61032 2JB



Low Depth Flush Mounting Box for Panelboard

External dimensions (mm): 408 x 380 x 75.
850 °C resistant back box suitable for installation in masonry or hollow walls.

61032 2GB

40 Modules (2x20)



Interior Fitting and Door for Flush Mounting Panelboard

External dimensions (mm): 505 x 400 x 35.

Accessories:

- Brass Terminal with 9 Neutral Connections (Ref. 60902) - 1 unit;
- Brass Terminal with 9 Earth Connections (Ref. 60903) - 1 unit;
- Brass Terminal with 20 Earth Connections (Ref. 60905) - 1 unit;
- Brass Terminal with 20 Neutral Connections (Ref. 60904) - 1 unit;
- Supplied with DIN rail, self-adhesive circuit identification sheet and labels and filler plate.

61040 2JB



Low Depth Flush Mounting Box for Panelboard

External dimensions (mm): 480 x 380 x 75.
850 °C resistant back box suitable for installation in masonry or hollow walls.

61040 2GB

48 Modules (2x24)



Interior Fitting and Door for Flush Mounting Panelboard

External dimensions (mm): 577 x 400 x 35.

Accessories:

- Brass Terminal with 9 Neutral Connections (Ref. 60902) - 2 units;
- Brass Terminal with 20 Neutral Connections (Ref. 60904) - 1 unit;
- Brass Terminal with 20 Earth Connections (Ref. 60905) - 2 units;
- Supplied with DIN rail, self-adhesive circuit identification sheet and labels and filler plate.

61048 2JB



Low Depth Flush Mounting Box for Panelboard

External dimensions (mm): 552 x 380 x 75.
850 °C resistant back box suitable for installation in masonry or hollow walls.

61048 2GB

60 Modules (3x20)



Interior Fitting and Door for Flush Mounting Panelboard

External dimensions (mm): 505 x 525 x 35.

Accessories:

- Brass Terminal with 9 Neutral Connections (Ref. 60902) - 2 units;
- Brass Terminal with 20 Neutral Connections (Ref. 60904) - 1 unit;
- Brass Terminal with 20 Earth Connections (Ref. 60905) - 2 units;
- Supplied with DIN rail, self-adhesive circuit identification sheet and labels and filler plate.

61060 3JB



Low Depth Flush Mounting Box for Panelboard

External dimensions (mm): 480 x 505 x 75.
850 °C resistant back box suitable for installation in masonry or hollow walls.

61060 3GB

80 Modules (4x20)



Interior Fitting and Door for Flush Mounting Panelboard

External dimensions (mm): 505 x 650 x 35.

Accessories:

- Brass Terminal with 9 Neutral Connections (Ref. 60902) - 1 unit;
- Brass Terminal with 20 Neutral Connections (Ref. 60904) - 2 units;
- Brass Terminal with 20 Earth Connections (Ref. 60905) - 3 units;
- Supplied with DIN rail, self-adhesive circuit identification sheet and labels and filler plate (2 units).

61080 4JB







Low Depth Flush Mounting Box for Panelboard

External dimensions (mm): 480 x 630 x 75.
850 °C resistant back box suitable for installation in masonry or hollow walls.

61080 4GB



External dimensions (mm): **W** - Width x **H** - Height x **D** - Depth.

Distribution Panelboard - Complete

		ref.	mod.	rows
4 Modules (1x4)	 <p>Complete Low Depth Flush Mounting Distribution Panelboard External dimensions (mm): 217 x 275 x 110. 850 °C resistant back box suitable for installation in masonry or hollow walls. Accessories: - Brass Terminal with 9 Neutral Connections (Ref. 60902) - 1 unit; - Brass Terminal with 9 Earth Connections (Ref. 60903) - 1 unit; - Supplied with DIN rail, self-adhesive circuit identification sheet and labels.</p>	61004 1AB	4	1
8 Modules (1x8)	 <p>Complete Low Depth Flush Mounting Distribution Panelboard External dimensions (mm): 289 x 275 x 110. 850 °C resistant back box suitable for installation in masonry or hollow walls. Accessories: - Brass Terminal with 9 Neutral Connections (Ref. 60902) - 1 unit; - Brass Terminal with 9 Earth Connections (Ref. 60903) - 1 unit; - Supplied with DIN rail, self-adhesive circuit identification sheet and labels.</p>	61008 1AB	8	1
12 Modules (1x12)	 <p>Complete Low Depth Flush Mounting Distribution Panelboard External dimensions (mm): 361 x 275 x 110. 850 °C resistant back box suitable for installation in masonry or hollow walls. Accessories: - Brass Terminal with 9 Neutral Connections (Ref. 60902) - 1 unit; - Brass Terminal with 9 Earth Connections (Ref. 60903) - 1 unit; - Supplied with DIN rail, self-adhesive circuit identification sheet and labels.</p>	61012 1AB	12	1
16 Modules (2x8)	 <p>Complete Low Depth Flush Mounting Distribution Panelboard External dimensions (mm): 289 x 400 x 110. 850 °C resistant back box suitable for installation in masonry or hollow walls. Accessories: - Brass Terminal with 9 Neutral Connections (Ref. 60902) - 1 unit; - Brass Terminal with 9 Earth Connections (Ref. 60903) - 1 unit; - Supplied with DIN rail, self-adhesive circuit identification sheet and labels.</p>	61016 2AB	16	2
24 Modules (2x12)	 <p>Complete Low Depth Flush Mounting Distribution Panelboard External dimensions (mm): 361 x 400 x 110. 850 °C resistant back box suitable for installation in masonry or hollow walls. Accessories: - Brass Terminal with 9 Neutral Connections (Ref. 60902) - 2 units; - Brass Terminal with 20 Earth Connections (Ref. 60905) - 1 unit; - Supplied with DIN rail, self-adhesive circuit identification sheet and labels and filler plate.</p>	61024 2AB	24	2

External dimensions (mm): **W** - Width x **H** - Height x **D** - Depth.

Distribution Panelboard - Complete

		ref.	mod.	rows
32 Modules (2x16)				
	<p>Complete Low Depth Flush Mounting Distribution Panelboard External dimensions (mm): 433 x 400 x 110. 850 °C resistant back box suitable for installation in masonry or hollow walls. Accessories: - Brass Terminal with 9 Neutral Connections (Ref. 60902) - 2 units; - Brass Terminal with 9 Earth Connections (Ref. 60903) - 1 unit; - Brass Terminal with 20 Earth Connections (Ref. 60905) - 1 unit; - Supplied with DIN rail, self-adhesive circuit identification sheet and labels and filler plate.</p>	61032 2AB	32	2
40 Modules (2x20)				
	<p>Complete Low Depth Flush Mounting Distribution Panelboard External dimensions (mm): 505 x 400 x 110. 850 °C resistant back box suitable for installation in masonry or hollow walls. Accessories: - Brass Terminal with 9 Neutral Connections (Ref. 60902) - 1 unit; - Brass Terminal with 9 Earth Connections (Ref. 60903) - 1 unit; - Brass Terminal with 20 Earth Connections (Ref. 60905) - 1 unit; - Brass Terminal with 20 Neutral Connections (Ref. 60904) - 1 unit; - Supplied with DIN rail, self-adhesive circuit identification sheet and labels and filler plate.</p>	61040 2AB	40	2
48 Modules (2x24)				
	<p>Complete Low Depth Flush Mounting Distribution Panelboard External dimensions (mm): 577 x 400 x 110. 850 °C resistant back box suitable for installation in masonry or hollow walls. Accessories: - Brass Terminal with 9 Neutral Connections (Ref. 60902) - 2 units; - Brass Terminal with 20 Neutral Connections (Ref. 60904) - 1 unit; - Brass Terminal with 20 Earth Connections (Ref. 60905) - 2 units; - Supplied with DIN rail, self-adhesive circuit identification sheet and labels and filler plate.</p>	61048 2AB	48	2
60 Modules (3x20)				
	<p>Complete Low Depth Flush Mounting Distribution Panelboard External dimensions (mm): 505 x 525 x 110. 850 °C resistant back box suitable for installation in masonry or hollow walls. Accessories: - Brass Terminal with 9 Neutral Connections (Ref. 60902) - 2 units; - Brass Terminal with 20 Neutral Connections (Ref. 60904) - 1 unit; - Brass Terminal with 20 Earth Connections (Ref. 60905) - 2 units; - Supplied with DIN rail, self-adhesive circuit identification sheet and labels and filler plate.</p>	61060 3AB	60	3
80 Modules (4x20)				
	<p>Complete Low Depth Flush Mounting Distribution Panelboard External dimensions (mm): 505 x 650 x 110. 850 °C resistant back box suitable for installation in masonry or hollow walls. Accessories: - Brass Terminal with 9 Neutral Connections (Ref. 60902) - 1 unit; - Brass Terminal with 20 Neutral Connections (Ref. 60904) - 2 units; - Brass Terminal with 20 Earth Connections (Ref. 60905) - 3 units; - Supplied with DIN rail, self-adhesive circuit identification sheet and labels and filler plate (2 units).</p>	61080 4AB	80	4

External dimensions (mm): **W** - Width x **H** - Height x **D** - Depth.

Telecommunications box

COMPLETE LOW DEPTH FLUSH MOUNTING



Telecom Complete Box Recessed Low Depth























External dimensions (mm): **572 x 801 x 110**.

850 °C resistant back box suitable for installation in masonry or hollow walls.

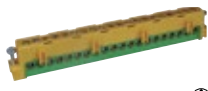

ref. **61048 2UB**

The product meets the requirements of the Spanish **ICT2** regulation.

Accessories

			ref.
	Panelboard Keylock		60900
	Panelboard Rotary Lever Lock		60910
	Installation Kit for Hollow-Wall Flush Mounting Boxes		60914
	Connection for Panelboard Boxes with Cable Pass		60915
 	Brass Terminal with 9 Phase Connections		60901
 	Brass Terminal with 9 Neutral Connections		60902
 	Brass Terminal with 9 Earth Connections		60903
 	Brass Terminal with 20 Neutral Connections		60904
 	Brass Terminal with 20 Earth Connections		60905
	Filler Plate 10 Modules		60906

 Distribution Panelboard
 Telecommunication Panelboard

 /  /  - Screw Connection

gamma

Standard Panelboard



When space is a priority

113 mm Back Box and **35 mm Door**, provides space to make wiring easy to organise.

Designed to also incorporate the ICB Incomer Panelboard (Power Control Device).

Several installation possibilities of Brass Terminals.

Reversible door.

Opens up to 180°.

Easy to maintain, quick removal of masks.

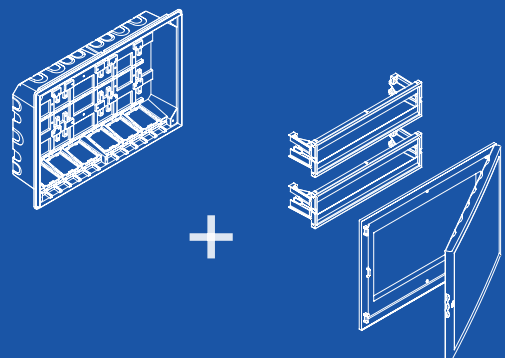

Distribution Panelboard - Semi-assembled

4 Modules (1x4)



Interior Fitting and Door for Flush Mounting Panelboard

External dimensions (mm): 217 x 275 x 35.

Accessories:

- Brass Terminal with 9 Neutral Connections (Ref. 60902) - 1 unit;
- Brass Terminal with 9 Earth Connections (Ref. 60903) - 1 unit;
- Supplied with DIN rail, self-adhesive circuit identification sheet and labels.

ref.

60004 1JB



Flush Mounting Box for Panelboard

External dimensions (mm): 192 x 255 x 113.
850 °C resistant back box suitable for installation in masonry or hollow walls.

ref.

60004 1GB

8 Modules (1x8)



Interior Fitting and Door for Flush Mounting Panelboard

External dimensions (mm): 289 x 275 x 35.

Accessories:

- Brass Terminal with 9 Neutral Connections (Ref. 60902) - 1 unit;
- Brass Terminal with 9 Earth Connections (Ref. 60903) - 1 unit;
- Supplied with DIN rail, self-adhesive circuit identification sheet and labels.

60008 1JB



Flush Mounting Box for Panelboard

External dimensions (mm): 264 x 255 x 113.
850 °C resistant back box suitable for installation in masonry or hollow walls.

60008 1GB

12 Modules (1x12)



Interior Fitting and Door for Flush Mounting Panelboard

External dimensions (mm): 361 x 275 x 35.

Accessories:

- Brass Terminal with 9 Neutral Connections (Ref. 60902) - 1 unit;
- Brass Terminal with 9 Earth Connections (Ref. 60903) - 1 unit;
- Supplied with DIN rail, self-adhesive circuit identification sheet and labels.

60012 1JB



Flush Mounting Box for Panelboard

External dimensions (mm): 336 x 255 x 113.
850 °C resistant back box suitable for installation in masonry or hollow walls.

60012 1GB

16 Modules (2x8)



Interior Fitting and Door for Flush Mounting Panelboard

External dimensions (mm): 289 x 400 x 35.

Accessories:

- Brass Terminal with 9 Neutral Connections (Ref. 60902) - 1 unit;
- Brass Terminal with 9 Earth Connections (Ref. 60903) - 1 unit;
- Supplied with DIN rail, self-adhesive circuit identification sheet and labels.

60016 2JB



Flush Mounting Box for Panelboard

External dimensions (mm): 264 x 380 x 113.
850 °C resistant back box suitable for installation in masonry or hollow walls.

60016 2GB

24 Modules (2x12)



Interior Fitting and Door for Flush Mounting Panelboard

External dimensions (mm): 361 x 400 x 35.

Accessories:

- Brass Terminal with 9 Neutral Connections (Ref. 60902) - 2 units;
- Brass Terminal with 20 Earth Connections (Ref. 60905) - 1 unit;
- Supplied with DIN rail, self-adhesive circuit identification sheet and labels and filler plate.

60024 2JB



Flush Mounting Box for Panelboard

External dimensions (mm): 336 x 380 x 113.
850 °C resistant back box suitable for installation in masonry or hollow walls.

60024 2GB

External dimensions (mm): W - Width x H - Height x D - Depth.

Distribution Panelboard - Semi-assembled

32 Modules (2x16)



Interior Fitting and Door for Flush Mounting Panelboard

External dimensions (mm): 433 x 400 x 35.

Accessories:

- Brass Terminal with 9 Neutral Connections (Ref. 60902) - 2 units;
- Brass Terminal with 9 Earth Connections (Ref. 60903) - 1 unit;
- Brass Terminal with 20 Earth Connections (Ref. 60905) - 1 unit;
- Supplied with DIN rail, self-adhesive circuit identification sheet and labels and filler plate.

ref.

60032 2JB



Flush Mounting Box for Panelboard

External dimensions (mm): 408 x 380 x 113.
850 °C resistant back box suitable for installation in masonry or hollow walls.

ref.

60032 2GB

40 Modules (2x20)



Interior Fitting and Door for Flush Mounting Panelboard

External dimensions (mm): 505 x 400 x 35.

Accessories:

- Brass Terminal with 9 Neutral Connections (Ref. 60902) - 1 unit;
- Brass Terminal with 9 Earth Connections (Ref. 60903) - 1 unit;
- Brass Terminal with 20 Earth Connections (Ref. 60905) - 1 unit;
- Brass Terminal with 20 Neutral Connections (Ref. 60904) - 1 unit;
- Supplied with DIN rail, self-adhesive circuit identification sheet and labels and filler plate.

60040 2JB



Flush Mounting Box for Panelboard

External dimensions (mm): 480 x 380 x 113.
850 °C resistant back box suitable for installation in masonry or hollow walls.

60040 2GB

48 Modules (2x24)



Interior Fitting and Door for Flush Mounting Panelboard

External dimensions (mm): 577 x 400 x 35.

Accessories:

- Brass Terminal with 9 Neutral Connections (Ref. 60902) - 2 units;
- Brass Terminal with 20 Neutral Connections (Ref. 60904) - 1 unit;
- Brass Terminal with 20 Earth Connections (Ref. 60905) - 2 units;
- Supplied with DIN rail, self-adhesive circuit identification sheet and labels and filler plate.

60048 2JB



Flush Mounting Box for Panelboard

External dimensions (mm): 552 x 380 x 113.
850 °C resistant back box suitable for installation in masonry or hollow walls.

60048 2GB

60 Modules (3x20)



Interior Fitting and Door for Flush Mounting Panelboard

External dimensions (mm): 505 x 525 x 35.

Accessories:

- Brass Terminal with 9 Neutral Connections (Ref. 60902) - 2 units;
- Brass Terminal with 20 Neutral Connections (Ref. 60904) - 1 unit;
- Brass Terminal with 20 Earth Connections (Ref. 60905) - 2 units;
- Supplied with DIN rail, self-adhesive circuit identification sheet and labels and filler plate.

60060 3JB



Flush Mounting Box for Panelboard

External dimensions (mm): 480 x 505 x 113.
850 °C resistant back box suitable for installation in masonry or hollow walls.

60060 3GB

80 Modules (4x20)



Interior Fitting and Door for Flush Mounting Panelboard

External dimensions (mm): 505 x 650 x 35.

Accessories:

- Brass Terminal with 9 Neutral Connections (Ref. 60902) - 1 unit;
- Brass Terminal with 20 Neutral Connections (Ref. 60904) - 2 units;
- Brass Terminal with 20 Earth Connections (Ref. 60905) - 3 units;
- Supplied with DIN rail, self-adhesive circuit identification sheet and labels and filler plate (2 units).

60080 4JB







Flush Mounting Box for Panelboard

External dimensions (mm): 480 x 630 x 113.
850 °C resistant back box suitable for installation in masonry or hollow walls.

60080 4GB





External dimensions (mm): **W** - Width x **H** - Height x **D** - Depth.

Distribution Panelboard - Complete

		ref.	mod.	rows
4 Modules (1x4)	 <p>Complete Flush Mounting Distribution Panelboard External dimensions (mm): 217 x 275 x 148. 850 °C resistant back box suitable for installation in masonry or hollow walls. Accessories: - Brass Terminal with 9 Neutral Connections (Ref. 60902) - 1 unit; - Brass Terminal with 9 Earth Connections (Ref. 60903) - 1 unit; - Supplied with DIN rail, self-adhesive circuit identification sheet and labels.</p>	60004 1AB	4	1
8 Modules (1x8)	 <p>Complete Flush Mounting Distribution Panelboard External dimensions (mm): 289 x 275 x 148. 850 °C resistant back box suitable for installation in masonry or hollow walls. Accessories: - Brass Terminal with 9 Neutral Connections (Ref. 60902) - 1 unit; - Brass Terminal with 9 Earth Connections (Ref. 60903) - 1 unit; - Supplied with DIN rail, self-adhesive circuit identification sheet and labels.</p>	60008 1AB	8	1
12 Modules (1x12)	 <p>Complete Flush Mounting Distribution Panelboard External dimensions (mm): 361 x 275 x 148. 850 °C resistant back box suitable for installation in masonry or hollow walls. Accessories: - Brass Terminal with 9 Neutral Connections (Ref. 60902) - 1 unit; - Brass Terminal with 9 Earth Connections (Ref. 60903) - 1 unit; - Supplied with DIN rail, self-adhesive circuit identification sheet and labels.</p>	60012 1AB	12	1
16 Modules (2x8)	 <p>Complete Flush Mounting Distribution Panelboard External dimensions (mm): 289 x 400 x 148. 850 °C resistant back box suitable for installation in masonry or hollow walls. Accessories: - Brass Terminal with 9 Neutral Connections (Ref. 60902) - 1 unit; - Brass Terminal with 9 Earth Connections (Ref. 60903) - 1 unit; - Supplied with DIN rail, self-adhesive circuit identification sheet and labels.</p>	60016 2AB	16	2
24 Modules (2x12)	 <p>Complete Flush Mounting Distribution Panelboard External dimensions (mm): 361 x 400 x 148. 850 °C resistant back box suitable for installation in masonry or hollow walls. Accessories: - Brass Terminal with 9 Neutral Connections (Ref. 60902) - 2 units; - Brass Terminal with 20 Earth Connections (Ref. 60905) - 1 unit; - Supplied with DIN rail, self-adhesive circuit identification sheet and labels and filler plate.</p>	60024 2AB	24	2

External dimensions (mm): **W** - Width x **H** - Height x **D** - Depth.

Distribution Panelboard - Complete

		ref.	mod.	rows
32 Modules (2x16)	 <p>Complete Flush Mounting Distribution Panelboard External dimensions (mm): 433 x 400 x 148. 850 °C resistant back box suitable for installation in masonry or hollow walls. Accessories: - Brass Terminal with 9 Neutral Connections (Ref. 60902) - 2 units; - Brass Terminal with 9 Earth Connections (Ref. 60903) - 1 unit; - Brass Terminal with 20 Earth Connections (Ref. 60905) - 1 unit; - Supplied with DIN rail, self-adhesive circuit identification sheet and labels and filler plate.</p>	60032 2AB	32	2
40 Modules (2x20)	 <p>Complete Flush Mounting Distribution Panelboard External dimensions (mm): 505 x 400 x 148. 850 °C resistant back box suitable for installation in masonry or hollow walls. Accessories: - Brass Terminal with 9 Neutral Connections (Ref. 60902) - 1 unit; - Brass Terminal with 9 Earth Connections (Ref. 60903) - 1 unit; - Brass Terminal with 20 Earth Connections (Ref. 60905) - 1 unit; - Brass Terminal with 20 Neutral Connections (Ref. 60904) - 1 unit; - Supplied with DIN rail, self-adhesive circuit identification sheet and labels and filler plate.</p>	60040 2AB	40	2
48 Modules (2x24)	 <p>Complete Flush Mounting Distribution Panelboard External dimensions (mm): 577 x 400 x 148. 850 °C resistant back box suitable for installation in masonry or hollow walls. Accessories: - Brass Terminal with 9 Neutral Connections (Ref. 60902) - 2 units; - Brass Terminal with 20 Neutral Connections (Ref. 60904) - 1 unit; - Brass Terminal with 20 Earth Connections (Ref. 60905) - 2 units; - Supplied with DIN rail, self-adhesive circuit identification sheet and labels and filler plate.</p>	60048 2AB	48	2
60 Modules (3x20)	 <p>Complete Flush Mounting Distribution Panelboard External dimensions (mm): 505 x 525 x 148. 850 °C resistant back box suitable for installation in masonry or hollow walls. Accessories: - Brass Terminal with 9 Neutral Connections (Ref. 60902) - 2 units; - Brass Terminal with 20 Neutral Connections (Ref. 60904) - 1 unit; - Brass Terminal with 20 Earth Connections (Ref. 60905) - 2 units; - Supplied with DIN rail, self-adhesive circuit identification sheet and labels and filler plate.</p>	60060 3AB	60	3
80 Modules (4x20)	 <p>Complete Flush Mounting Distribution Panelboard External dimensions (mm): 505 x 650 x 148. 850 °C resistant back box suitable for installation in masonry or hollow walls. Accessories: - Brass Terminal with 9 Neutral Connections (Ref. 60902) - 1 unit; - Brass Terminal with 20 Neutral Connections (Ref. 60904) - 2 units; - Brass Terminal with 20 Earth Connections (Ref. 60905) - 3 units; - Supplied with DIN rail, self-adhesive circuit identification sheet and labels and filler plate (2 units).</p>	60080 4AB	80	4

External dimensions (mm): **W** - Width x **H** - Height x **D** - Depth.

ICB Incomer Panelboard - Semi-assembled

16 Modules (2x8) + ICB



ICB Interior Fitting and Door for Flush Mounting Panelboard

External dimensions (mm): 433 x 400 x 35.

Accessories:

- Brass Terminal with 9 Neutral Connections (Ref. 60902) - 1 unit;
- Brass Terminal with 9 Earth Connections (Ref. 60903) - 1 unit;
- Supplied with DIN rail, self-adhesive circuit identification sheet and labels and filler plate.

ref.

60016 2KB



Flush Mounting Box for Panelboard

External dimensions (mm): 408 x 380 x 113.
850 °C resistant back box suitable for installation in masonry or hollow walls.

ref.

60032 2GB

24 Modules (2x12) + ICB



ICB Interior Fitting and Door for Flush Mounting Panelboard

External dimensions (mm): 505 x 400 x 35.

Accessories:

- Brass Terminal with 9 Neutral Connections (Ref. 60902) - 2 units;
- Brass Terminal with 20 Earth Connections (Ref. 60905) - 1 unit;
- Supplied with DIN rail, self-adhesive circuit identification sheet and labels and filler plate.

60024 2KB



Flush Mounting Box for Panelboard

External dimensions (mm): 480 x 380 x 113.
850 °C resistant back box suitable for installation in masonry or hollow walls.

60040 2GB

32 Modules (2x16) + ICB



ICB Interior Fitting and Door for Flush Mounting Panelboard

External dimensions (mm): 577 x 400 x 35.

Accessories:

- Brass Terminal with 9 Neutral Connections (Ref. 60902) - 2 units;
- Brass Terminal with 20 Earth Connections (Ref. 60905) - 1 unit;
- Supplied with DIN rail, self-adhesive circuit identification sheet and labels and filler plate.

60032 2KB



Flush Mounting Box for Panelboard

External dimensions (mm): 552 x 380 x 113.
850 °C resistant back box suitable for installation in masonry or hollow walls.

60048 2GB

44 Modules (2x12+1x20) + ICB



ICB Interior Fitting and Door for Flush Mounting Panelboard

External dimensions (mm): 505 x 525 x 35.

Accessories:

- Brass Terminal with 9 Neutral Connections (Ref. 60902) - 1 unit;
- Brass Terminal with 20 Neutral Connections (Ref. 60904) - 1 unit;
- Brass Terminal with 20 Earth Connections (Ref. 60905) - 2 units;
- Supplied with DIN rail, self-adhesive circuit identification sheet and labels and filler plate.

60044 3KB



Flush Mounting Box for Panelboard

External dimensions (mm): 480 x 505 x 113.
850 °C resistant back box suitable for installation in masonry or hollow walls.

60060 3GB

64 Modules (2x12+2x20) + ICB



ICB Interior Fitting and Door for Flush Mounting Panelboard

External dimensions (mm): 505 x 650 x 35.

Accessories:

- Brass Terminal with 9 Neutral Connections (Ref. 60902) - 2 units;
- Brass Terminal with 20 Neutral Connections (Ref. 60904) - 1 unit;
- Brass Terminal with 20 Earth Connections (Ref. 60905) - 2 units;
- Supplied with DIN rail, self-adhesive circuit identification sheet and labels and filler plate (2 units).

60064 4KB







Flush Mounting Box for Panelboard

External dimensions (mm): 480 x 630 x 113.
850 °C resistant back box suitable for installation in masonry or hollow walls.

60080 4GB

ICB - Incomer Circuit Breaker (Power Control Device) for Panelboard.
External dimensions (mm): L - Width x A - Height x P - Depth

ICB Incomer Panelboard - Complete

		ref.	mod.	rows
16 Modules (2x8) + ICB	 <p>Complete Flush Mounting Incomer Panelboard External dimensions (mm): 433 x 400 x 148. 850 °C resistant back box suitable for installation in masonry or hollow walls. Accessories: - Brass Terminal with 9 Neutral Connections (Ref. 60902) - 1 unit; - Brass Terminal with 9 Earth Connections (Ref. 60903) - 1 unit; - Supplied with DIN rail, self-adhesive circuit identification sheet and labels and filler plate</p>	60016 2BB	16	2
24 Modules (2x12) + ICB	 <p>Complete Flush Mounting Incomer Panelboard External dimensions (mm): 505 x 400 x 148. 850 °C resistant back box suitable for installation in masonry or hollow walls. Accessories: - Brass Terminal with 9 Neutral Connections (Ref. 60902) - 2 units; - Brass Terminal with 20 Earth Connections (Ref. 60905) - 1 unit; - Supplied with DIN rail, self-adhesive circuit identification sheet and labels and filler plate</p>	60024 2BB	24	2
32 Modules (2x16) + ICB	 <p>Complete Flush Mounting Incomer Panelboard External dimensions (mm): 577 x 400 x 148. 850 °C resistant back box suitable for installation in masonry or hollow walls. Accessories: - Brass Terminal with 9 Neutral Connections (Ref. 60902) - 2 units; - Brass Terminal with 20 Earth Connections (Ref. 60905) - 1 unit; - Supplied with DIN rail, self-adhesive circuit identification sheet and labels and filler plate</p>	60032 2BB	32	2
44 Modules (2x12+1x20) + ICB	 <p>Complete Flush Mounting Incomer Panelboard External dimensions (mm): 505 x 525 x 148. 850 °C resistant back box suitable for installation in masonry or hollow walls. Accessories: - Brass Terminal with 9 Neutral Connections (Ref. 60902) - 1 unit; - Brass Terminal with 20 Neutral Connections (Ref. 60904) - 1 unit; - Brass Terminal with 20 Earth Connections (Ref. 60905) - 2 units; - Supplied with DIN rail, self-adhesive circuit identification sheet and labels and filler plate</p>	60044 3BB	44	3
64 Modules (2x12+2x20) + ICB	 <p>Complete Flush Mounting Incomer Panelboard External dimensions (mm): 505 x 650 x 148. 850 °C resistant back box suitable for installation in masonry or hollow walls. Accessories: - Brass Terminal with 9 Neutral Connections (Ref. 60902) - 2 units; - Brass Terminal with 20 Neutral Connections (Ref. 60904) - 1 unit; - Brass Terminal with 20 Earth Connections (Ref. 60905) - 2 units; - Supplied with DIN rail, self-adhesive circuit identification sheet and labels and filler plate (2 units).</p>	60064 4BB	64	4

ICB - Incomer Circuit Breaker (Power Control Device) for Panelboard.
 External dimensions (mm): **W** - Width x **H** - Height x **D** - Depth.

Telecommunication Panelboard - Semi-assembled

ref.

ref.

6 Coaxial Cable Outputs (CC) and up to 12 Copper Pair Outputs (CP)



Interior Fitting and Door for Telecom Panelboard

External dimensions (mm): 577 x 400 x 35.

Accessories:

- CP Splitter with connectors Cat. 6 UTP
- (1 input, 6 outputs, expandable to 12 outputs);
- Double Coaxial Splitter (2 inputs and 2 x 6 outputs);
- OF Splitter with SC/APC Simplex Optical Fibre Coupler;
- Schuko Socket (Ref. 45132 SBR).

60048 2LB



Flush Mounting Box for Panelboard

External dimensions (mm): 552 x 380 x 113.
850 °C resistant back box suitable for installation in masonry or hollow walls.

60048 2GB

8 Coaxial Cable Outputs (CC) and up to 24 Copper Pair Outputs (CP)



Interior Fitting and Door for Telecom Panelboard

External dimensions (mm): 505 x 525 x 35.

Accessories:

- CP Splitter with connectors Cat. 6 UTP
- (1 input, 8 outputs, expandable to 24 outputs);
- Double Coaxial Splitter (2 inputs and 2 x 8 outputs);
- OF Splitter with SC/APC Simplex Optical Fibre Coupler;
- Schuko Socket (Ref. 45132 SBR).

60060 3NB



Flush Mounting Box for Panelboard

External dimensions (mm): 480 x 505 x 113.
850 °C resistant back box suitable for installation in masonry or hollow walls.

60060 3GB

12 Coaxial Cable Outputs (CC) and up to 24 Copper Pair Outputs (CP)



Interior Fitting and Door for Telecom Panelboard

External dimensions (mm): 505 x 525 x 35.

Accessories:

- CP Splitter with connectors Cat. 6 UTP
- (1 input, 12 outputs, expandable to 24 outputs);
- Double Coaxial Splitter (2 inputs and 2 x 12 outputs);
- OF Splitter with SC/APC Simplex Optical Fibre Coupler;
- Schuko Socket (Ref. 45132 SBR).

60060 3MB



Flush Mounting Box for Panelboard

External dimensions (mm): 480 x 505 x 113.
850 °C resistant back box suitable for installation in masonry or hollow walls.

60060 3GB

Auxiliary Telecommunication Panelboard - Semi-assembled

6 Coaxial Cable Outputs (CC) and up to 12 Copper Pair Outputs (CP)



Door for Telecom Panelboard Back Box - 48 Modules

External dimensions (mm): 577 x 400 x 35.

60048 2QB



Flush Mounting Box for Panelboard

External dimensions (mm): 552 x 380 x 113.
850 °C resistant back box suitable for installation in masonry or hollow walls.

60048 2GB

12 Coaxial Cable Outputs (CC) and up to 24 Copper Pair Outputs (CP)



Door for Telecom Panelboard Back Box - 60 Modules

External dimensions (mm): 505 x 525 x 35.

60060 3RB



Flush Mounting Box for Panelboard

External dimensions (mm): 480 x 505 x 113.
850 °C resistant back box suitable for installation in masonry or hollow walls.

60060 3GB

CC - Coaxial Cable Outputs; PC - Copper Pair Outputs.
External dimensions (mm): W - Width x H - Height x D - Depth.

Telecommunication Panelboard - Complete

ref.

6 Coaxial Cable Outputs (CC) and up to 12 Copper Pair Outputs (CP)**Complete Flush Mounting Telecom Panelboard**External dimensions (mm): **577 x 400 x 148**;

850 °C resistant back box suitable for installation in masonry or hollow walls.

Accessories:

- CP Splitter with connectors Cat. 6 UTP (1 input, 6 outputs, expandable to 12 outputs);
- Double Coaxial Splitter (2 inputs and 2 x 6 outputs);
- OF Splitter with SC/APC Simplex Optical Fibre Coupler;
- Schuko Socket (Ref. 45132 SBR).

60048 2PB**8 Coaxial Cable Outputs (CC) and up to 24 Copper Pair Outputs (CP)****Complete Flush Mounting Telecom Panelboard**External dimensions (mm): **505 x 525 x 148**;

850 °C resistant back box suitable for installation in masonry or hollow walls.

Accessories:

- CP Splitter with connectors Cat. 6 UTP (1 input, 8 outputs, expandable to 24 outputs);
- Double Coaxial Splitter (2 inputs and 2 x 8 outputs);
- OF Splitter with SC/APC Simplex Optical Fibre Coupler;
- Schuko Socket (Ref. 45132 SBR)

60060 3SB**12 Coaxial Cable Outputs (CC) and up to 24 Copper Pair Outputs (CP)****Complete Flush Mounting Telecom Panelboard**External dimensions (mm): **505 x 525 x 148**;

850 °C resistant back box suitable for installation in masonry or hollow walls.

Accessories:

- CP Splitter with connectors Cat. 6 UTP (1 input, 12 outputs, expandable to 24 outputs);
- Double Coaxial Splitter (2 inputs and 2 x 12 outputs);
- OF Splitter with SC/APC Simplex Optical Fibre Coupler;
- Schuko Socket (Ref. 45132 SBR).

60060 3PB

Auxiliary Telecommunication Panelboard - Complete

6 Coaxial Cable Outputs (CC) and up to 12 Copper Pair Outputs (CP)**Auxiliary Box for Complete Flush Mounting Telecom Panelboard**External dimensions (mm): **577 x 400 x 148**.

850 °C resistant back box suitable for installation in masonry or hollow walls.





























60048 2UB**12 Coaxial Cable Outputs (CC) and up to 24 Copper Pair Outputs (CP)****Auxiliary Box for Complete Flush Mounting Telecom Panelboard**External dimensions (mm): **505 x 525 x 148**.

850 °C resistant back box suitable for installation in masonry or hollow walls.

60060 3UB

CC - Coaxial Cable Outputs; PC - Copper Pair Outputs.
External dimensions (mm): W - Width x H - Height x D - Depth.

Accessories

			ref.
	Panelboard Keylock		60900
	Panelboard Rotary Lever Lock		60910
	Installation Kit for Hollow-Wall Flush Mounting Boxes		60914
	Connection for Panelboard Boxes with Cable Pass		60915
	Brass Terminal with 9 Phase Connections		60901
	Brass Terminal with 9 Neutral Connections		60902
	Brass Terminal with 9 Earth Connections		60903
	Brass Terminal with 20 Neutral Connections		60904
	Brass Terminal with 20 Earth Connections		60905
	Coaxial Splitter 2x6 Outputs 5 - 862 MHz: 11 dB 950 - 2400 MHz: 15 dB F-Type, 5-2400 MHz, Flow DC 30 V 700 mA		60911
	Coaxial Splitter 2x8 Outputs 5 - 862 MHz: 12,5 dB 950 - 2400 MHz: 16 dB F-Type, 5-2400 MHz, Flow DC 30 V 700 mA		60913
	Coaxial Splitter 2x12 Outputs 5 - 862 MHz: 15,5 dB 950 - 2400 MHz: 21 dB F-Type, 5-2400 MHz, Flow DC 30 V 700 mA.		60912
	Filler Plate 10 Modules		60906
	Optical Fibre Terminal Box		60907

 **Distribution** Panelboard
 **Telecommunication** Panelboard

 - Screw Connection

Technical Information

Distribution Panelboard | ICB Incomer Panelboard

Description

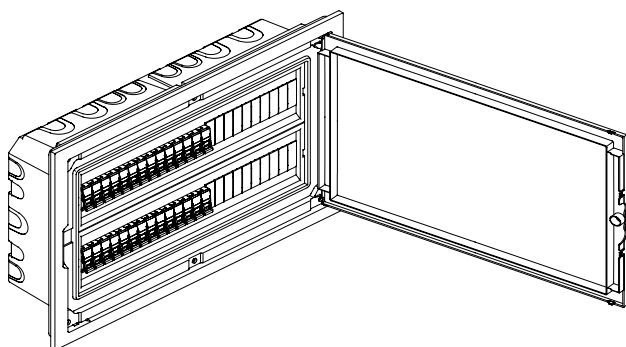

omega

Low Profile Distribution Panelboard allow modular switchgear to be fixed.

Standard: EN 62208 / EN 61439-3.

IK07

Insulation Class: II.

White Color - RAL 9003.

Reversible door.

Rotary Lever Lock or Keylock option.

Removable frame.

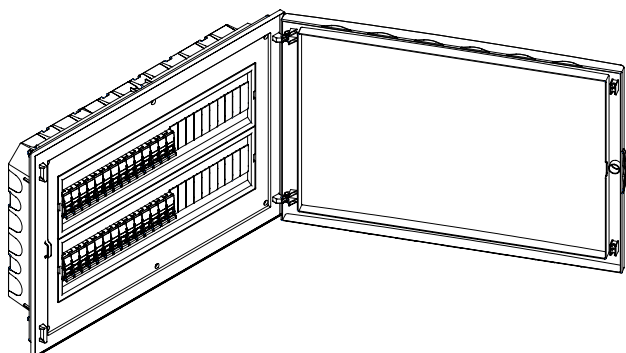

beta

Low Depth Distribution Panelboard allow modular switchgear to be fixed.

Standard: EN 62208 / EN 61439-3.

IK07

Insulation Class: II.

White Color - RAL 9003.

Reversible door opens up to 180°.

Rotary Lever Lock or Keylock option.

Removable frame.

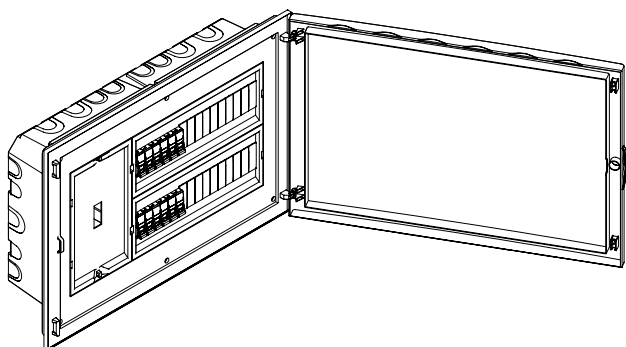

gamma

Distribution Panelboard allow modular switchgear to be fixed.

ICB Incomer Panels allow modular switchgear to be fixed and Incomer Circuit Breaker (Power Control Device) for Panelboard. (ICB).

Standard: EN 62208 / EN 61439-3.

IK07

Insulation Class: II.

White Color - RAL 9003.

Reversible door opens up to 180°.

Rotary Lever Lock or Keylock option.

Compatibility Chart - Semi-assembled

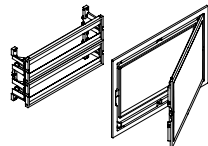
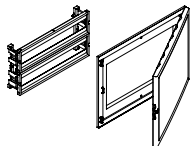
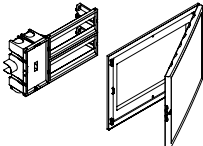
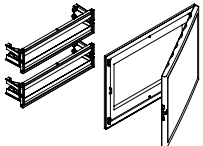
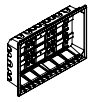
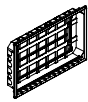
	 omega (Distribution) 620xx xJB	 beta (Distribution) 610xx xJB	 gamma (ICB) 600xx xKB	 gamma (Distribution) 600xx xJB
 Standard Back Box 600xx xGB	✓	✗	✓	✓
 Low Depth Back Box 610xx xGB	✗	✓	✗	✗

• xx x - Digits to be set for the product code

Distribution Panelboard | ICB Incomer Panelboard

Dimensions (mm)

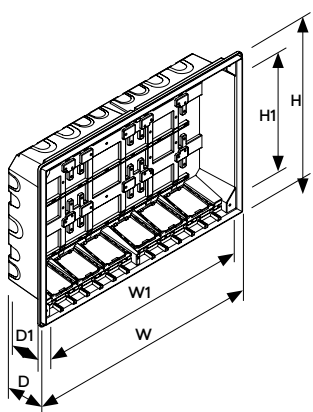

omega / gamma

Flush Mounting Back Boxes for Panelboards

Ref.	W (mm)	H (mm)	D (mm)	W1 (mm)	H1 (mm)	D1 (mm)
60004	192	255	113	170	188	92
60008	264	255	113	242	188	92
60012	336	255	113	314	188	92
60016	264	380	113	242	313	92
60024	336	380	113	314	313	92
60032	408	380	113	386	313	92
60040	480	380	113	458	313	92
60048	552	380	113	530	313	92
60060	480	505	113	458	438	92
60080	480	630	113	458	563	92

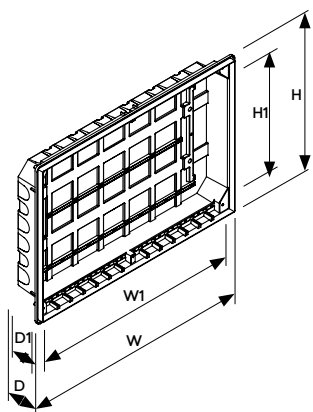

beta

Low Depth Flush Mounting Back Boxes for Panelboards

Ref.	W (mm)	H (mm)	D (mm)	W1 (mm)	H1 (mm)	D1 (mm)
61004	192	255	75	170	194	65
61008	264	255	75	242	194	65
61012	336	255	75	314	194	65
61016	264	380	75	242	319	65
61024	336	380	75	314	319	65
61032	408	380	75	386	319	65
61040	480	380	75	458	319	65
61048	552	380	75	530	319	65
61060	480	505	75	458	444	65
61080	480	630	75	458	569	65

Door Dimensions (mm)

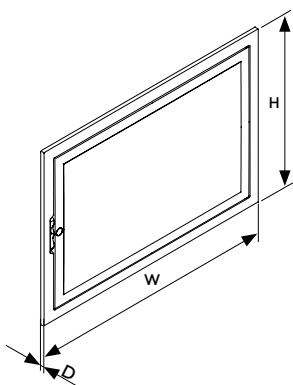

omega / gamma

Ref.	W (mm)	H (mm)	D (mm)
62004	217	275	11
62008	289	275	11
62012	361	275	11
62016	289	400	11
62024	361	400	11
62032	433	400	11
62040	505	400	11
62048	577	400	11
62060	505	525	11
62080	505	650	11

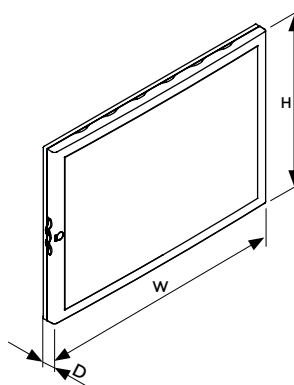

beta / gamma

Ref.	W (mm)	H (mm)	D (mm)
60004 61004	217	275	35
60008 61008	289	275	35
60012 61012	361	275	35
60016 61016	289	400	35
60024 61024	361	400	35
60032 61032	433	400	35
60040 61040	505	400	35
60048 61048	577	400	35
60060 61060	505	525	35
60080 61080	505	650	35

Installation for Hollow Wall Flush Mounting Boxes

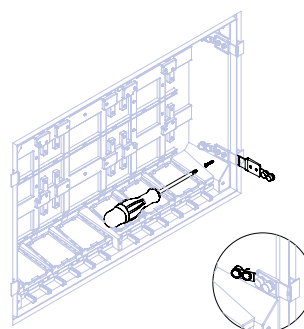
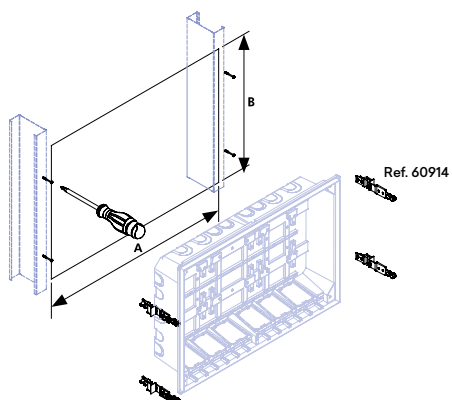

Ref.	A (mm)	B (mm)
60004 61004	197	260
60008 61008	269	260
60012 61012	341	260
60016 61016	269	385
60024 61024	341	385
60032 61032	413	385
60040 61040	485	385
60048 61048	557	385
60060 61060	485	510
60080 61080	485	635

Distribution Panelboard | ICB Incomer Panelboard

Assembly Diagram - Distribution Panelboard

omega / gamma

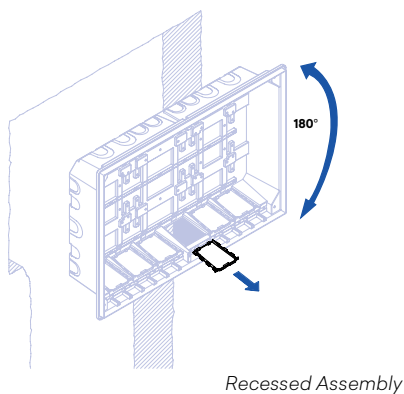

Recessed Assembly

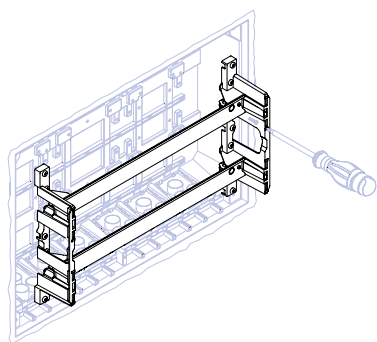
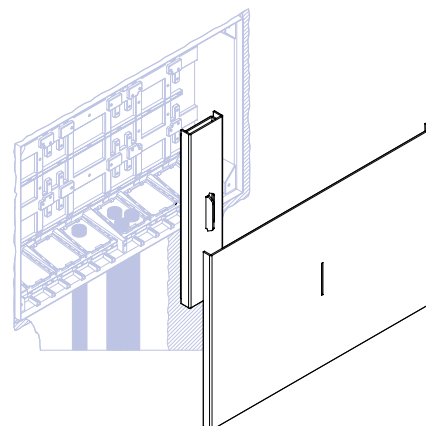
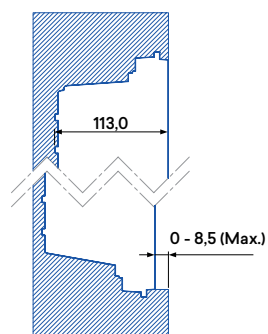

DIN Rail Installation

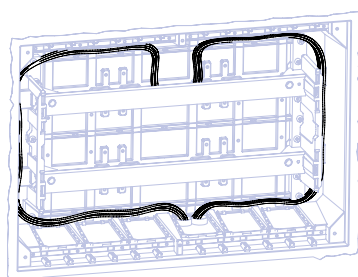

Easy Wiring

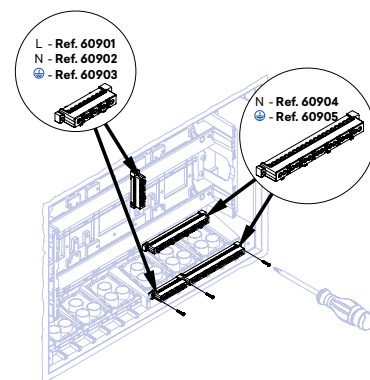

Brass Terminals Installation

beta

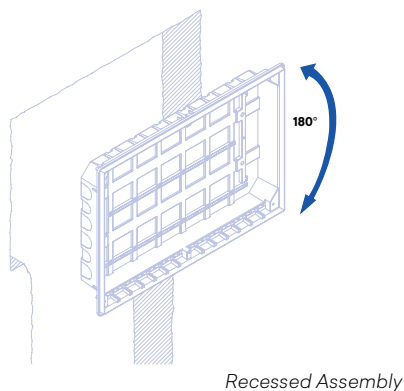

Recessed Assembly

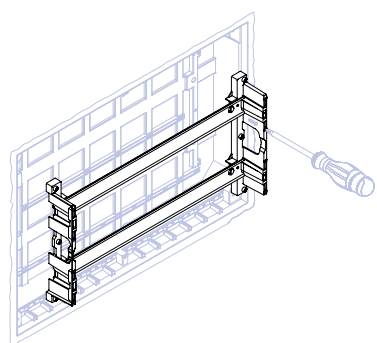
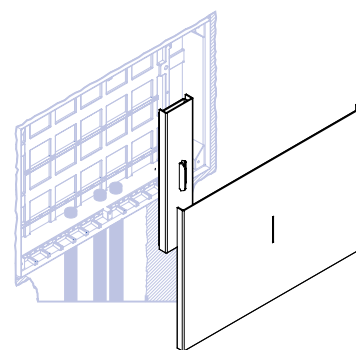
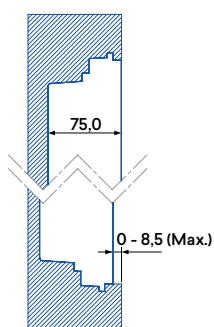

DIN Rail Installation

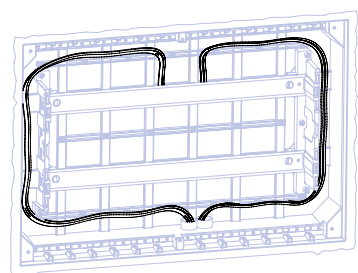

Easy Wiring

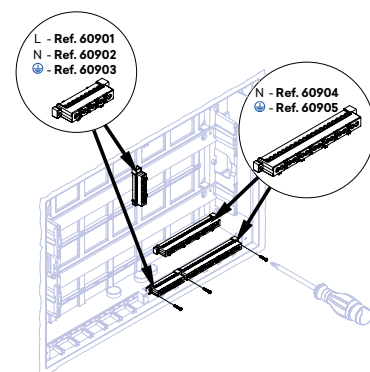

Brass Terminals Installation

Distribution Panelboard | ICB Incomer Panelboard

Assembly Diagram - ICB Incomer Panels

gamma

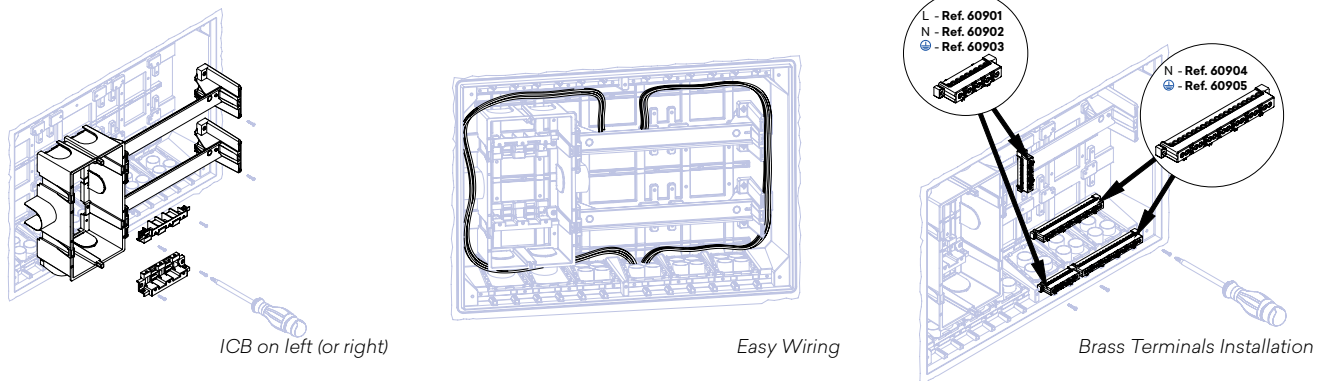

Assembly Diagram - Masks

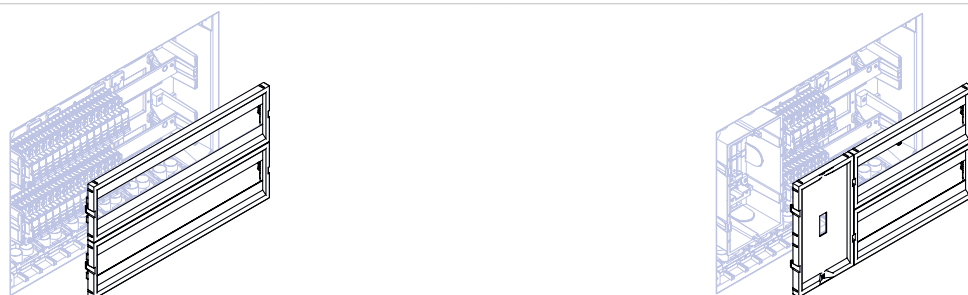

Assembly and Dismantling of Doorframe and Door

omega

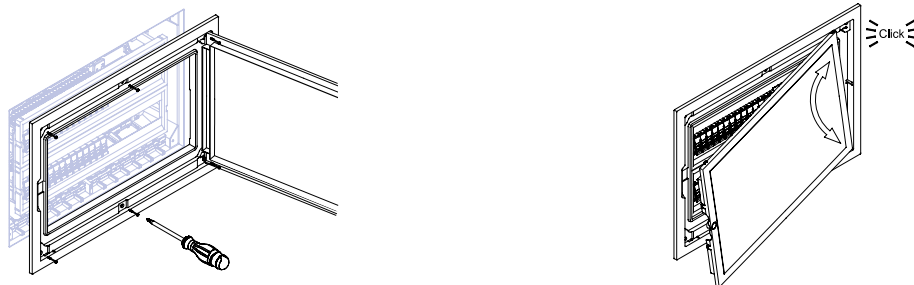

beta / gamma

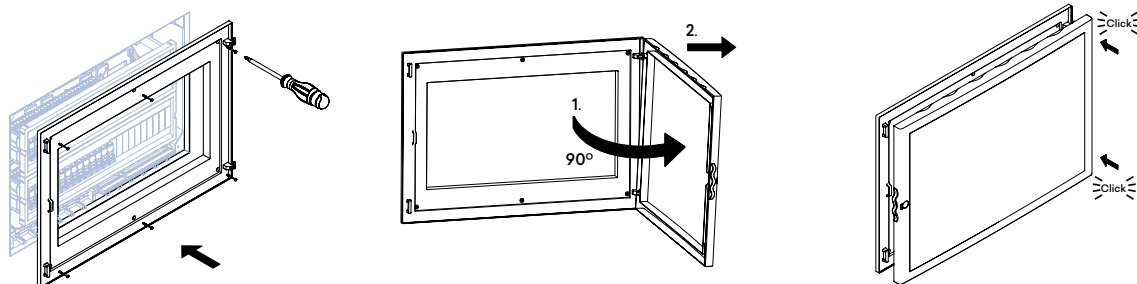

Rotary Lever Lock or Keylock Assembly

omega

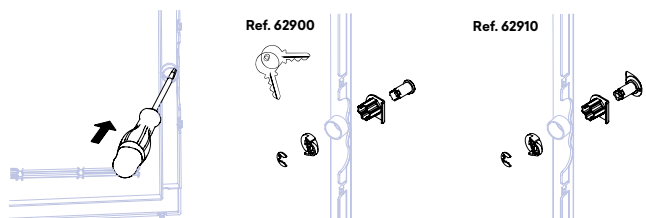

beta / gamma

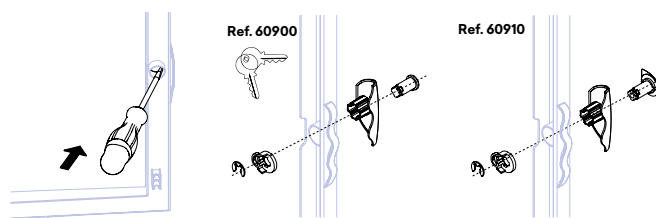

Distribution Panelboard | ICB Incomer Panelboard

Classification - Standard EN 62208

Section 4	Classification	Panelboard
a	Type of Material	Insulating
b	Type of Installation	Recessed Assembly
		To be installed in hollow walls.
c	Installation Location	Interior
d	Degrees of Protection	IP20 in accordance with IEC 60529
		IK07 in accordance with IEC 62262
e	Insulating Voltage	Ui=400 V; nominal current: In ≤ 63 A with 230-400 V
Section 6.3	Documentation	Panelboard
	Permissible loads	Maximum permissible load within the enclosure is 200 kg/m ³
		Do not apply weight to cover
	Lifting devices, where necessary	Not applicable
	Devices for protection from electric shocks	Not applicable, plastic enclosure
	Applicable conditions of use	Interior installation: Temperatures between -5 °C and +40 °C
	Data on capacity to dissipate thermal energy	Maximum interior thermal charge (1)

omega (1)		beta (1)		gamma (1)			
62004	12 W	61004	10 W	60004 1AB	12 W	60016 2BB	37 W
62008	16 W	61008	14 W	60008 1AB	16 W	60024 2BB	41 W
62012	21 W	61012	18 W	60012 1AB	21 W	60032 2BB	49 W
62016	24 W	61016	21 W	60016 2AB	24 W	60044 3BB	54 W
62024	29 W	61024	27 W	60024 2AB	29 W	60064 4BB	64 W
62032	37 W	61032	34 W	60032 2AB	37 W		
62040	41 W	61040	37 W	60040 2AB	41 W		
62048	49 W	61048	44 W	60048 2AB	49 W		
62060	54 W	61060	48 W	60060 3AB	54 W		
62080	64 W	61080	60 W	60080 4AB	64 W		

Specific Classification - Standard EN 61439-3

Section 5.6	Documentation	Panelboard
	Nominal Frequency (nf)	50 Hz
	Level of pollution	2
	Earth systems	TN
	Users	For use by people without training
	EMF environment	Type B
	Protection for people	Isolated command body and insulated enclosure - class II insulation
	Maximum stipulated short-circuit current for the protective devices (max. ICC)	10 kA
	Installation conditions	3.5.1 Interior
		3.5.3 Fixed
	Exterior design	3.3.3 Closed assembly
		3.3.10 Assembly for recessed wall mounting
	Type of DBO	3.1.103 DBO Type B

Note: Should not be assembled in high-risk areas, such as places subject to variations in temperature and high pressure, locations with strong magnetic fields, or atmospheres subject to explosions, fires, vibrations and exceptional voltage fluctuations.

Telecommunication Panelboard

Description

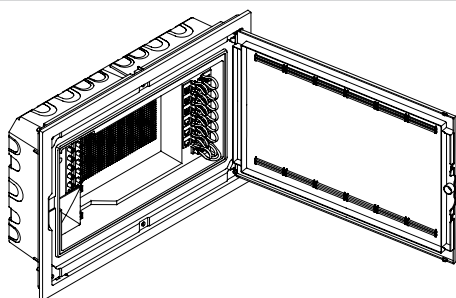

omega

- 6 Coaxial Cable Outputs (CC).
- Up to 12 Copper Pair Outputs (PC).

- 8 Coaxial Cable Outputs (CC).
- Up to 24 Copper Pair Outputs (PC).

- 12 Coaxial Cable Outputs (CC).
- Up to 24 Copper Pair Outputs (PC).

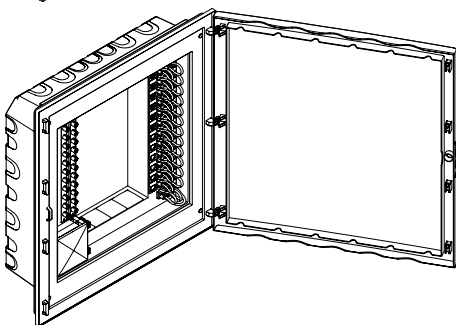

gamma

- Optical fibre organiser with 4 SC/APC couplers.
- Space available for live voltage equipment.
- Supplied with Schuko Socket.
- Supplied with Brass Terminal Earth Connection.
- White Color - RAL 9003.
- Reversible door.
- Rotary Lever Lock or Keylock option.

Note: Telecommunication panelboard not available in "BETA" Series.

Dimensions (mm)

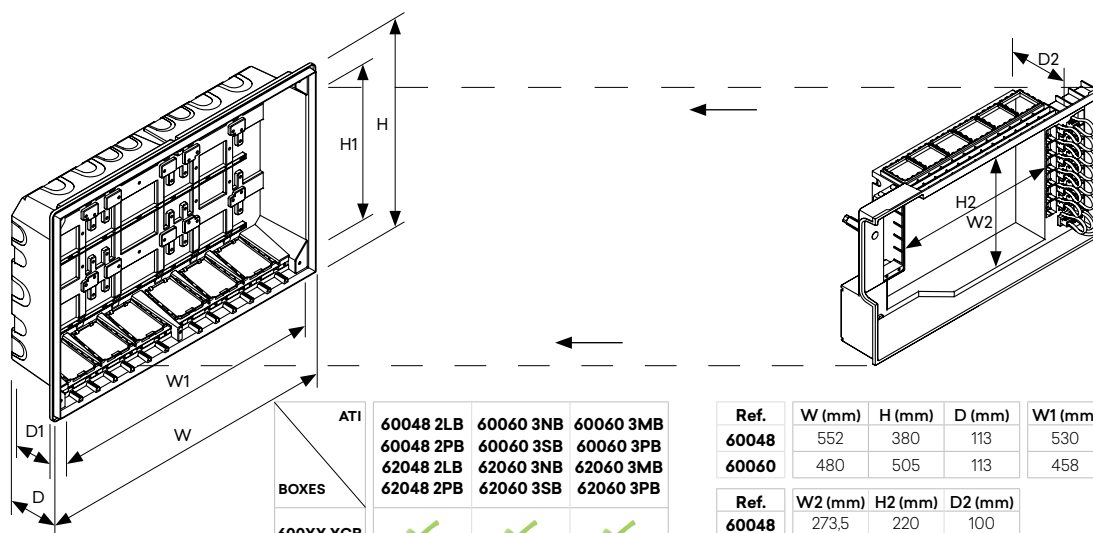

ATI	60048 2LB	60060 3NB	60060 3MB
BOXES	60048 2PB	60060 3SB	60060 3PB
	62048 2LB	62060 3NB	62060 3MB
	62048 2PB	62060 3SB	62060 3PB
600XX XGB	✓	✓	✓
610XX XGB	✗	✗	✗

Ref.	W (mm)	H (mm)	D (mm)	W1 (mm)	H1 (mm)	D1 (mm)
60048	552	380	113	530	313	92
60060	480	505	113	458	438	92

Ref.	W2 (mm)	H2 (mm)	D2 (mm)
60048	273,5	220	100
60060	201,5	320	100
62048	273,5	220	100
62060	201,5	320	100

Door Dimensions (mm)

omega

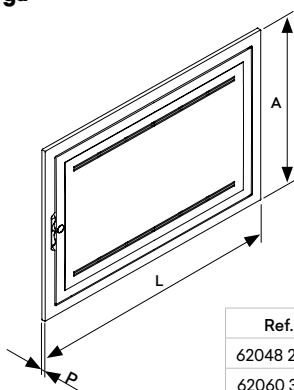

Ref.	W (mm)	H (mm)	D (mm)
62048 2QB	577	400	11
62060 3RB	505	525	11

gamma

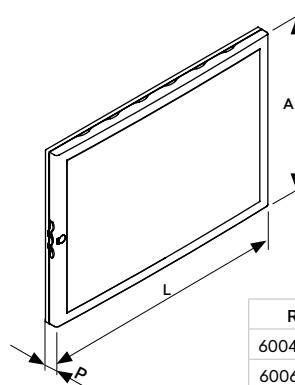

Ref.	W (mm)	H (mm)	D (mm)
60048 2QB	577	400	35
60060 3RB	505	525	35

Telecommunication Panelboard

Assembly Diagram

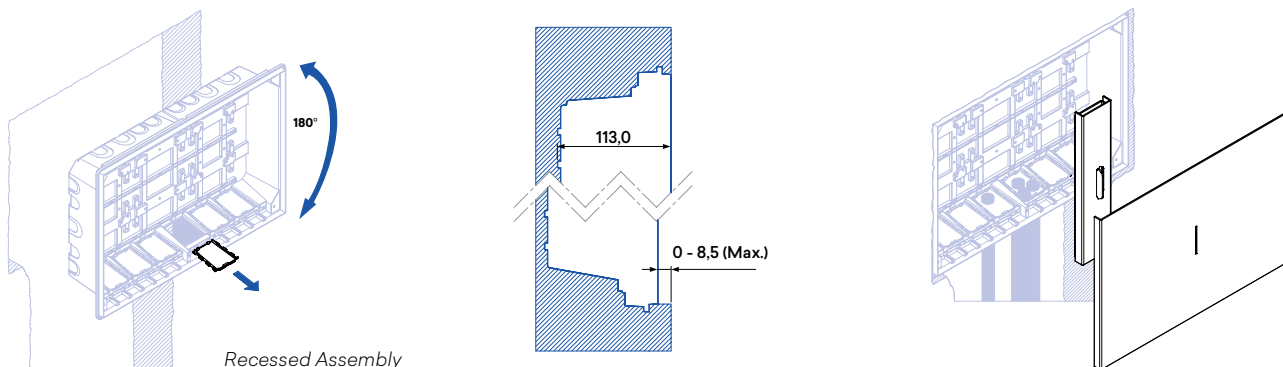

Recessed Assembly

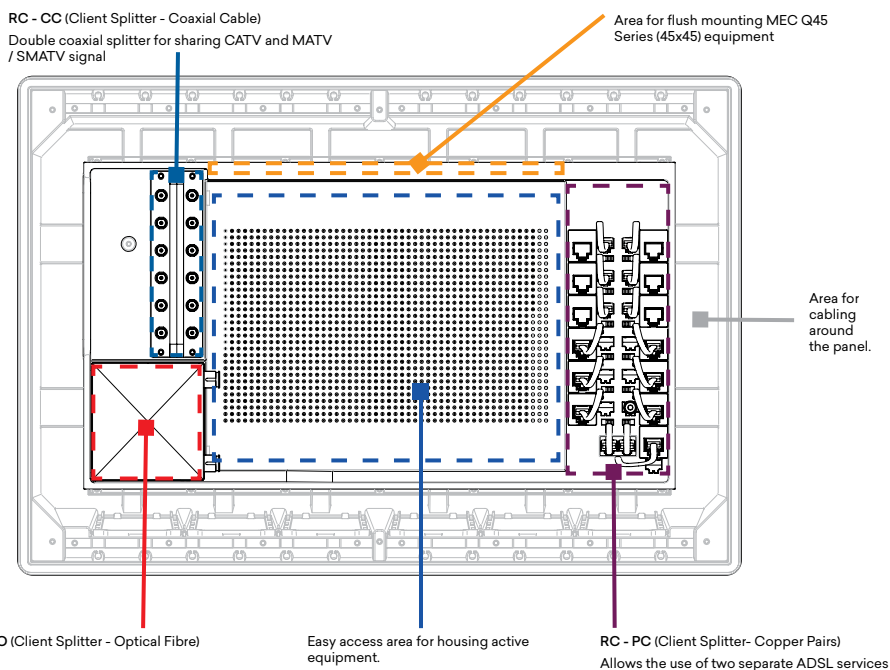

Telecom Panelboard Interior Assembly

Easy Wiring

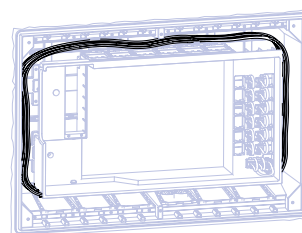
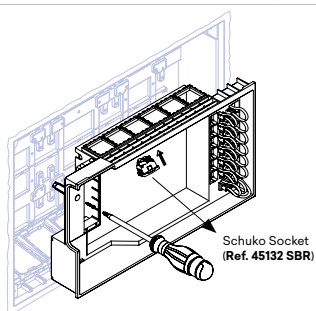

Characteristics

gamma

omega

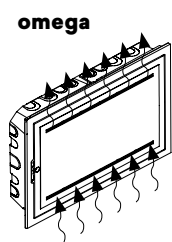
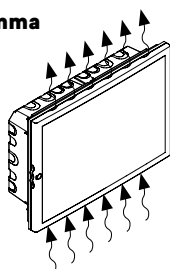

Heat dissipation capacity.
Space available for housing active equipment.
Possibility for multiple configurations through the installation of the MEC Q45 series modules (45x45).

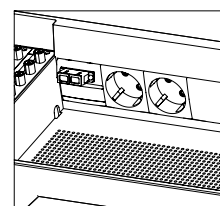

Telecommunication Panelboard

Assembly Diagram

RC - CC (CLIENT SPLITTER - COAXIAL CABLE)

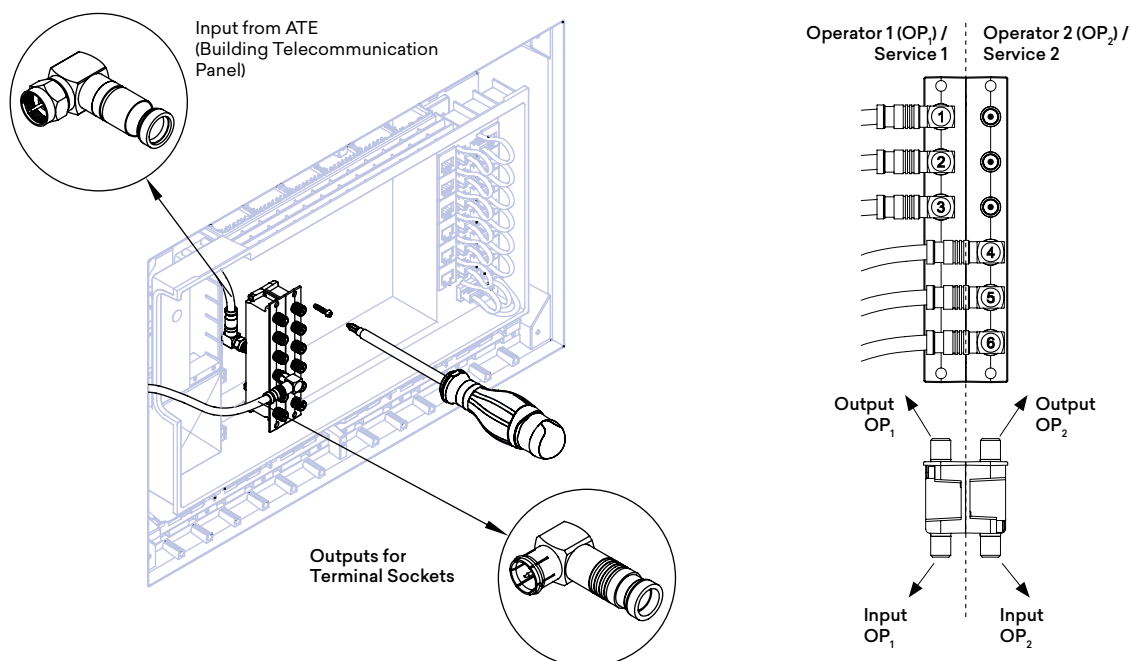

RC - CC (CLIENT SPLITTER - COAXIAL CABLE) - IMPEDANCE OF 75 Ohm

SPLITTER TYPE	CONNECTOR / OUTPUTS	NUMBER OF OUTPUTS	INSERTION LOSSES dB (*)			INSULATION BETWEEN OUTPUTS (dB)	RETURN LOSSES		FLOW DC OUTPUTS - INPUT
			5-1000 MHz	1000-2150 MHz	2150-2400 MHz		MHz	dB	
RC-CC6	F 	6	11	14	15	> 20 dB	5-40 40-1000 1000-1750 1750-2400	≥ 10,0 ≥ 13,0 ≥ 12,0 ≥ 11,0	YES MAX. 30 V _{DC} 700 mA
RC-CC8	F 	8	12,5	15	16		5-40 40-1000 1000-1750 1750-2400	≥ 10,0 ≥ 12,0 ≥ 12,0 ≥ 10,0	
RC-CC12	F 	12	15,5	19	21		5-40 40-300 300-1000 1000-1750 1750-2400	≥ 7,5 ≥ 8,5 ≥ 13,0 ≥ 12,0 ≥ 11,0	

(*) Nominal values (tolerance 2 dB)

RC - FO (CLIENT SPLITTER - OPTICAL FIBRE)

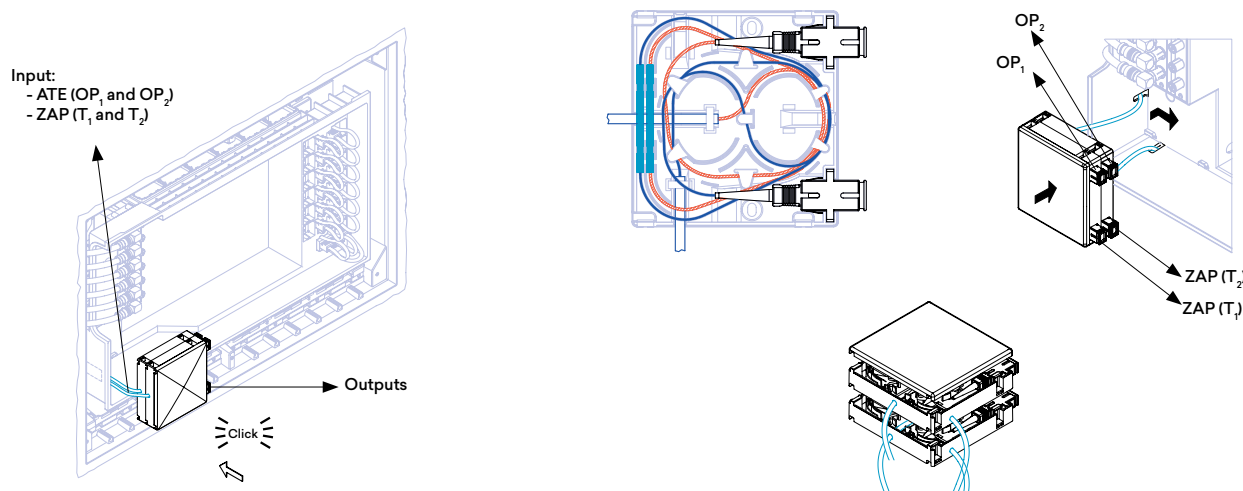

Telecommunication Panelboard

Assembly Diagram

RC - PC (CLIENT SPLITTER - COPPER PAIRS)

Section A

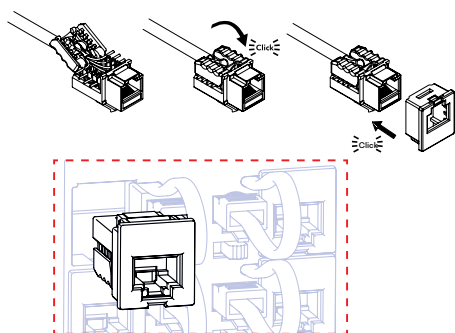

Section B

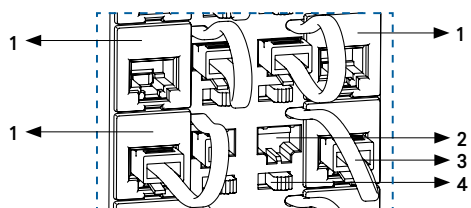

Section C

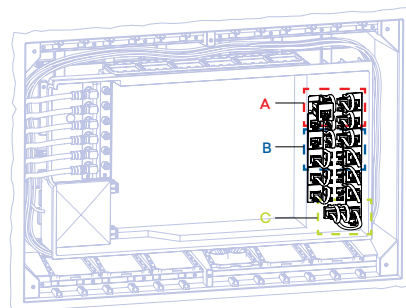
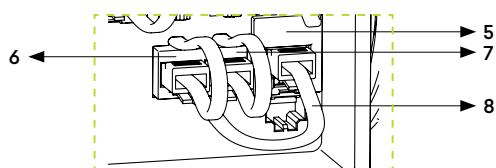

1. RJ45 connector, where the cable coming from the house telecommunications sockets is connected.
2. RJ45 plug holder dock.
3. Wire RJ45 plug with the telephone signal for Operator 1 or Operator 2 depending on the selector position. (Secondary)
4. Telephone operator selector
5. RJ45 connector, where the connection of the cable from the building's panel is made (Primary)
 - Operator 1 in pair 4-5;
 - Operator 2 in pair 6-3;
6. Operator 1.
7. Operator 2.
8. RC - CP input through a RJ45 plug.

ADSL Connection

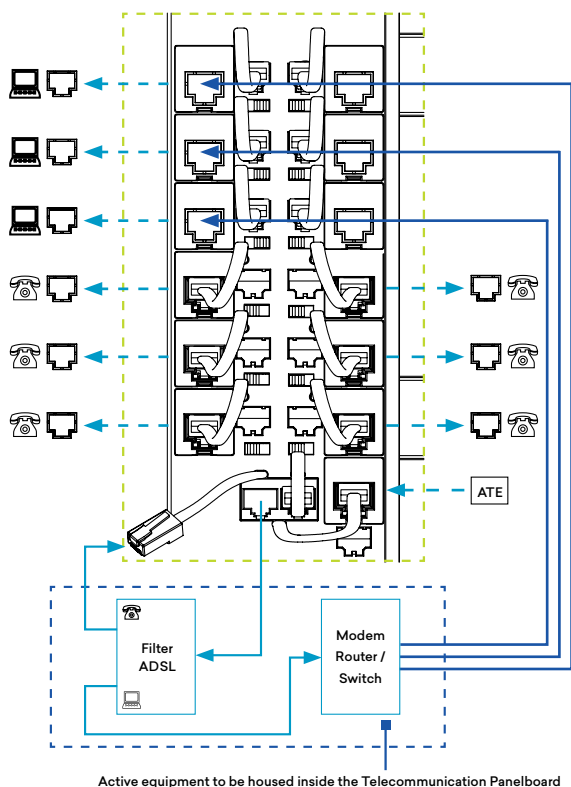

Telephone Distribution

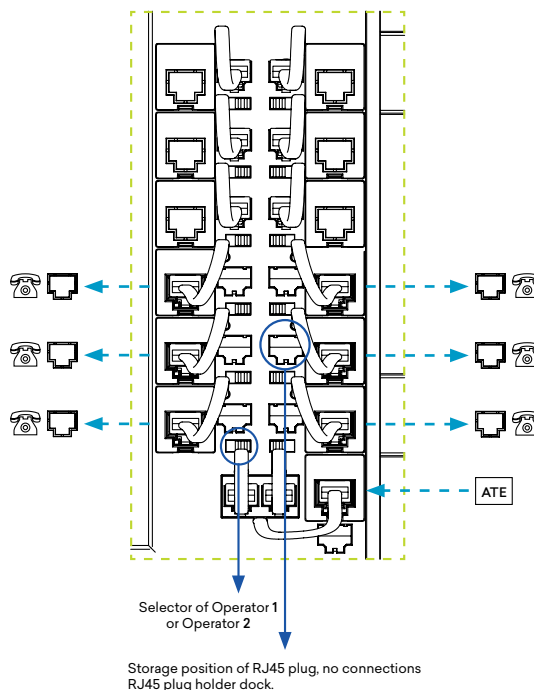

Telecommunication Panelboard

Assembly and Dismantling of Doorframe and Door

omega



gamma

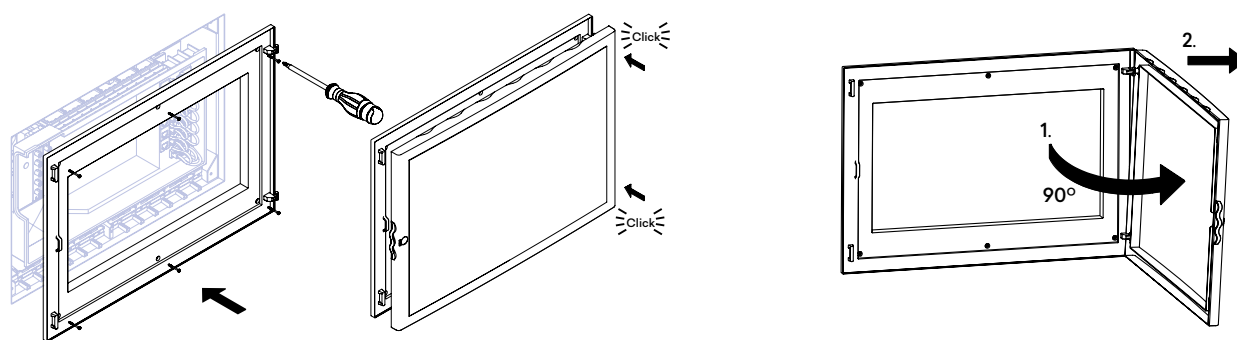

Rotary Lever Lock or Keylock Assembly

omega

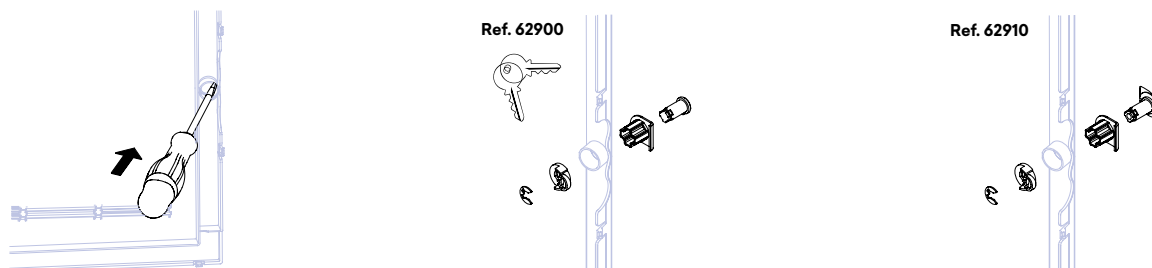

gamma

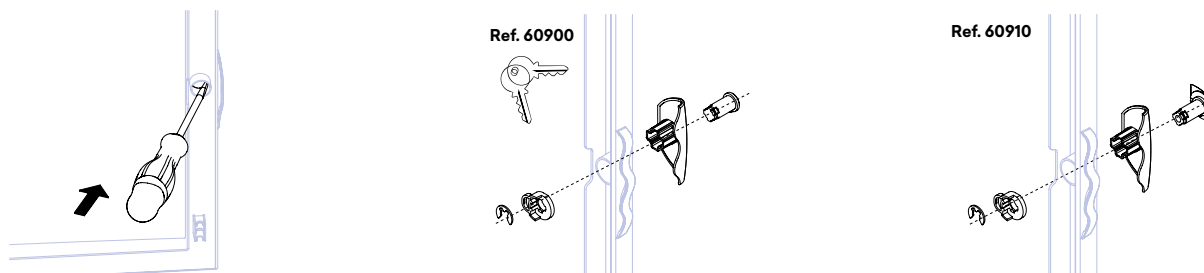

Telecommunication Panelboard

Classification - Standard EN 62208

Section 4	Classification	Panelboard		
a	Type of Material	Insulating		
b	Type of Installation	Recessed Assembly		
		To be installed in hollow walls.		
c	Installation Location	Interior		
d	Degrees of Protection	IP20 in accordance with IEC 60529		
		IK07 in accordance with IEC 62262		
e	Insulating Voltage	Ui=400 V; nominal current: In ≤ 63 A with 230/400 V		
Section 6.3	Documentation	Panelboard		
	Permissible loads	Maximum permissible load within the enclosure is 200 kg/m ³		
		Do not apply weight to cover		
	Lifting devices, where necessary	Not applicable		
	Devices for protection from electric shocks	Not applicable, plastic enclosure		
	Applicable conditions of use	Interior installation: Temperatures between -5 °C and +40 °C		
	Data on capacity to dissipate thermal energy	(60048 2LB, 60048 2PB, 60060 3NB, 60060 3SB, 60060 3MB, 60060 3PB)		
		Maximum interior thermal charge	60048	49 W
			60060	54 W
		(62048 2LB, 62048 2PB, 62060 3NB, 62060 3SB, 62060 3MB, 62060 3PB)		
Maximum interior thermal charge	62048	49 W		
	62060	54 W		

Telecommunications Box (Low Depth Flush Mounting) - beta

Dimensions (mm)

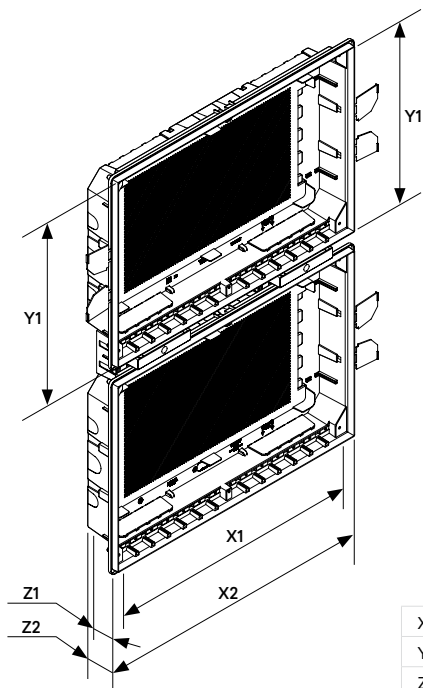

X1 (mm)	530
Y1 (mm)	313
Z1 (mm)	66
X2 (mm)	552
Z2 (mm)	75

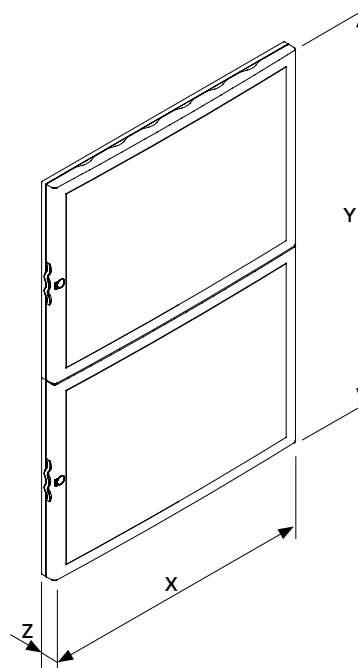

X (mm)	Y (mm)	Z (mm)
572	801	35

Recessed Assembly

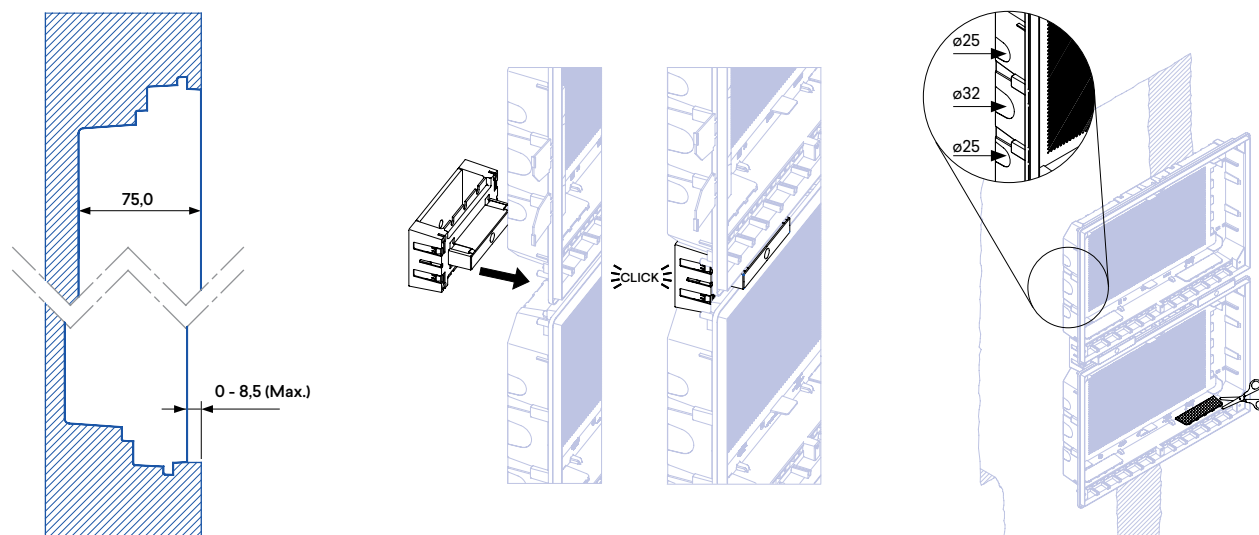

Telecommunications Box (Low Depth Flush Mounting) - beta

On Hollow Walls

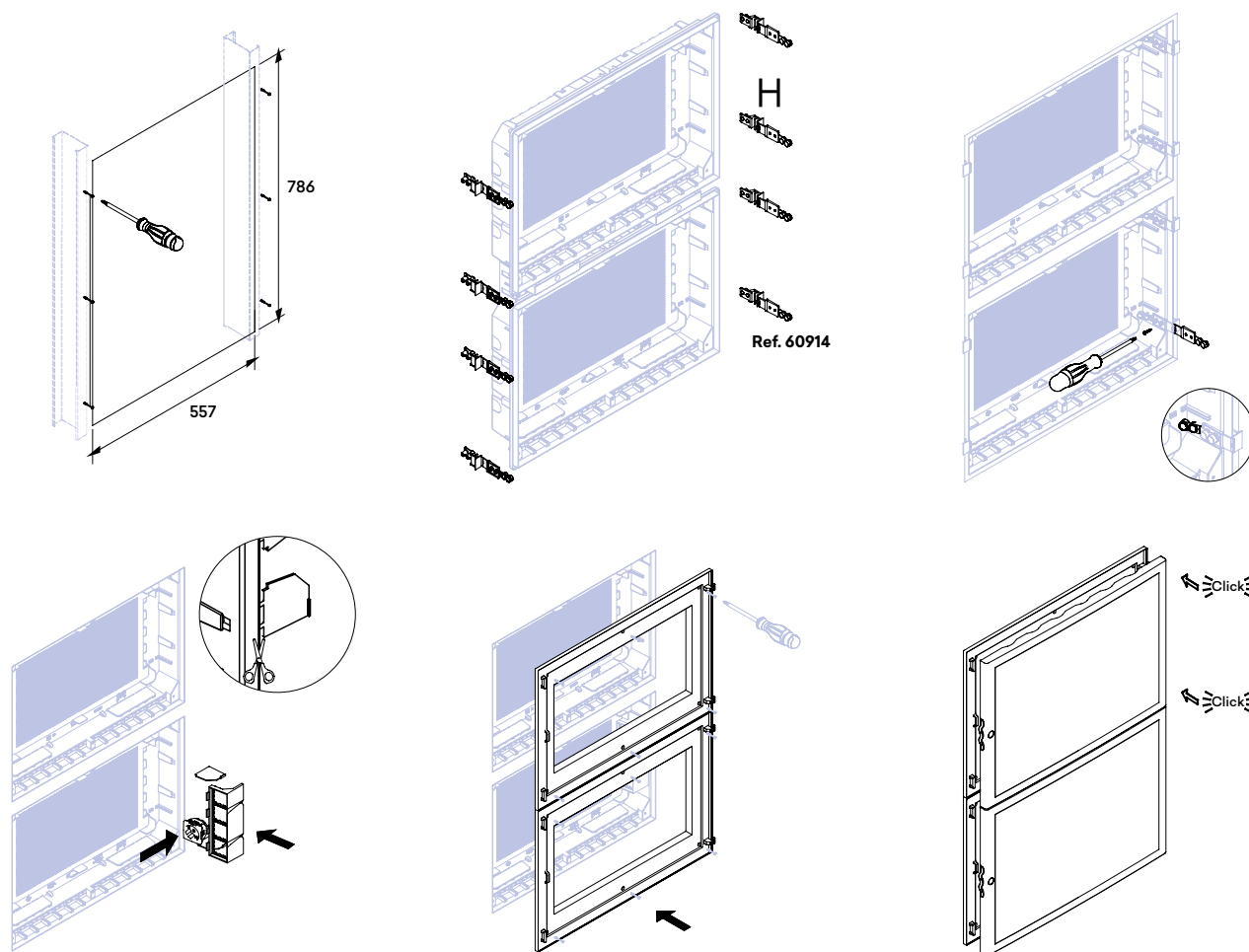

Classification - Standard EN 60670

Section 7	Classification	Telecommunications Panelboard
7.1	Nature of the material	Insulating
7.2	Type of installation	Recessed Assembly
		Intended to be installed on hollow walls H
7.5	Installation temperatures	-5 °C up to +60 °C
7.7	Degrees of Protection	IP20 in accordance with IEC 60529
7.8	Means of fixing the devices to the boxes	Boxes granted to receive screws



efapel.com



Serpins,
3200-355 Serpins
Portugal

Export
export@efapel.com
+351 239 970 135

SAT Technical Support Service
sat@efapel.com
+351 239 970 132



zastúpenie pre Slovenskú republiku:
EMAT elektro. s.r.o.
Pri Jelšine 3636/1
949 01 Nitra
mobil: +421 905 747 827
mail: efapel@emat.sk; eshop@emat.sk

